

# Motor Gasolines Technical Review

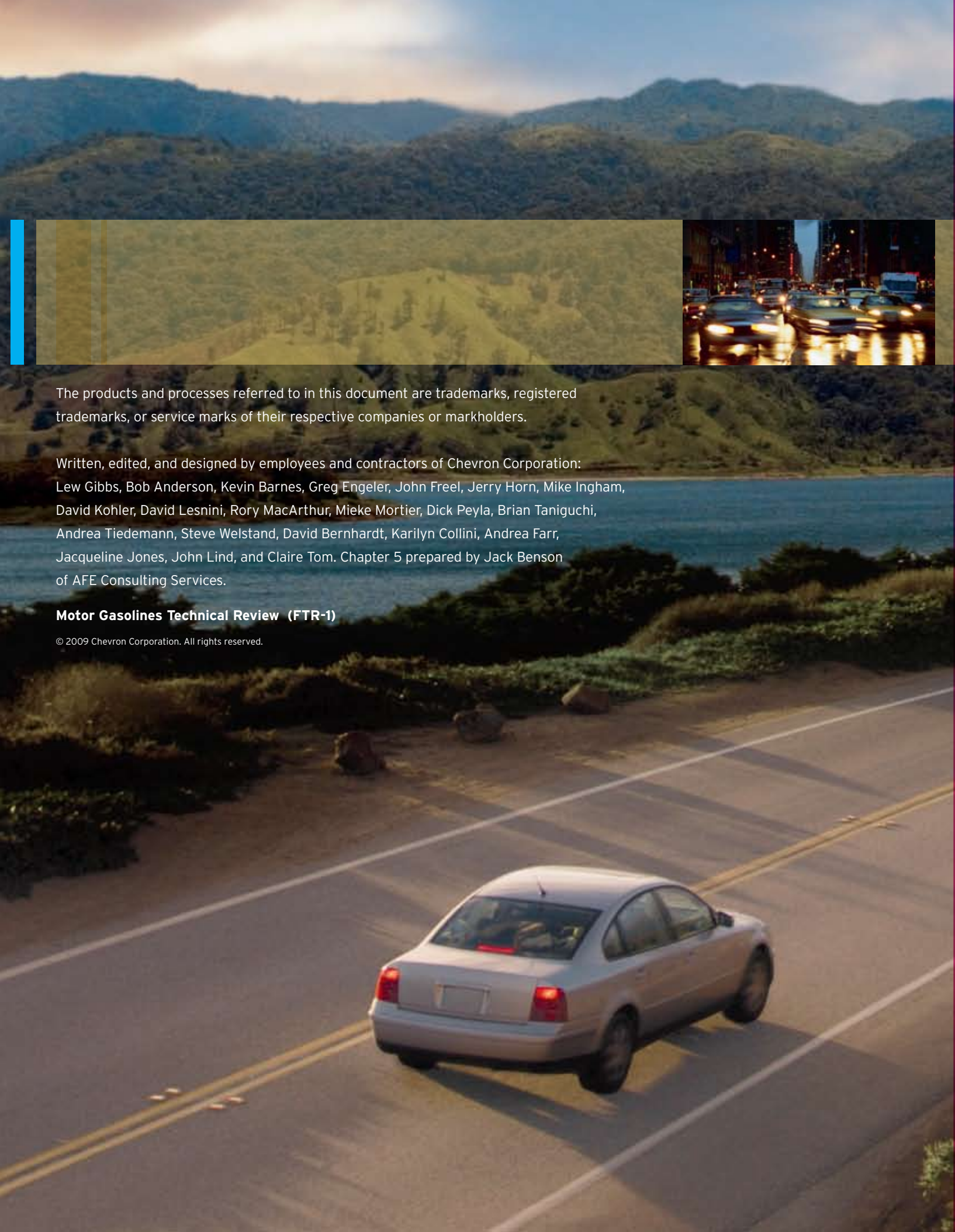



The products and processes referred to in this document are trademarks, registered trademarks, or service marks of their respective companies or markholders.

Written, edited, and designed by employees and contractors of Chevron Corporation:  
Lew Gibbs, Bob Anderson, Kevin Barnes, Greg Engeler, John Freel, Jerry Horn, Mike Ingham,  
David Kohler, David Lesnini, Rory MacArthur, Mieke Mortier, Dick Peyla, Brian Taniguchi,  
Andrea Tiedemann, Steve Welstand, David Bernhardt, Karilyn Collini, Andrea Farr,  
Jacqueline Jones, John Lind, and Claire Tom. Chapter 5 prepared by Jack Benson  
of AFE Consulting Services.

**Motor Gasolines Technical Review (FTR-1)**

© 2009 Chevron Corporation. All rights reserved.





# Motor Gasolines

Technical Review



Our Family of Brands



# Table of Contents

---

Introduction .....	i	5 • Gasoline Engines and Selected Systems .....	61
1 • Gasoline and Driving Performance .....	1	Conventional Engine Technology	
Volatility		Combustion Cycle	
Vapor Pressure		Engine Structure	
Distillation Profile		Air System	
Vapor-Liquid Ratio		Intake Air Pressurizing	
Vapor Lock Index		Positive Crankcase Ventilation	
Driveability Index		Fuel System	
Volatility Specifications		Carburetors	
Antiknock Performance		Injectors	
Octane Number Requirement		Storage	
Power		Exhaust System	
Fuel Economy		Catalytic Converter	
Factors Affecting Fuel Economy		Exhaust Gas Recirculation	
Fuel Economy Road Test		Control Systems	
Other Performance Factors		Fuel Control	
2 • Gasoline and Air Quality .....	13	Spark Control	
Progress in the United States		On-board Diagnostics	
Legislation		Advanced Engine Technology	
Administration/Regulation		Conventional Engine Modifications	
Air Quality Standards		Direct Injection	
Air Pollutants		Variable Valve Timing	
Origin of Vehicle Emissions		Cylinder Deactivation	
Vehicle Emissions: Limits		Variable Compression Ratio	
Inspection and Maintenance		Controlled Autoignition Combustion	
Vehicle Emissions: Gasoline Effects		Alternative Engine Technology	
Reformulated Gasolines		Hybrid Gasoline-Electric	
European Union		Fuel Cell Electric	
Japan		6 • Gasoline Vehicles – Deposit Control .....	77
3 • Gasoline Refining and Testing .....	31	Engine Deposits and Performance	
Composition		Historical Development of Deposit Control Additives	
About Hydrocarbons		No Harm and Compatibility	
Refining		Emissions	
Raw Material		Required Additive Use	
Refining Processes		TOP TIER Detergent Gasoline	
The Modern Refinery		Aftermarket Additives	
Processing Changes Required by		Handling Gasoline Safely .....	83
Air Pollution Regulations		Questions and Answers .....	89
Blending		Sources of More Information .....	95
Contamination and Adulteration		Abbreviations .....	99
Gasoline Additives		Index .....	103
Specifications			
4 • Oxygenated Gasoline .....	53		
Chemistry			
Use			
Sources			
Specifications			
Performance Issues			



# Introduction

---

In May 1876, Nicolaus Otto built the first practical four-stroke-cycle internal combustion engine powered by a liquid fuel. By 1884, he concluded development of his engine with the invention of the first magneto ignition system for low-voltage ignition. The liquid fuel used by Otto became known as gasoline in the United States; elsewhere it may be known as *gasolina*, *petrol*, *essence*, or *benzin* (not to be confused with the chemical compound benzene).

Although the U.S. petroleum industry was almost 50 years old when the first Model T rolled off Henry Ford's production line in 1908, gasoline and the automobile grew up together. The industry was born in August 1859 near Titusville, Pa., when a drilling effort financed by Edwin Drake hit crude oil at a depth of 70 feet (21 meters). The major product in the early years wasn't gasoline; it was lamp oil, called *coal oil* or *kerosene*.<sup>1</sup> People were reading more and wanted better light than that provided by candles and whale oil lamps. The natural gasoline in crude oil was a surplus byproduct. Being too volatile to use in lamps, it was burned at refineries, dumped, or converted to a gaseous fuel for gas lights.

The development of the electric light and the astonishing popularity of the automobile in the first decades of the 20th century turned the petroleum industry's focus from kerosene to gasoline. In 1911, gasoline sales exceeded kerosene sales for the first time. The simple engines in the first cars ran on almost any liquid that burned. As the demand for power increased and engines became more sophisticated, gasoline was recognized as the right fuel for the spark-ignition internal combustion engine.<sup>2</sup>

Drivers can obtain the performance they expect only when the characteristics of the fuel they use match the fuel requirements of the engines in their cars. As a result of this correlation, the gasoline engine and its fuel matured as mutually dependent partners. An engine was not designed without considering the gasolines available in the marketplace. In turn, gasoline was not made without considering the requirements of the engines that would burn it. The partnership became a triumvirate in the last decades of the 20th century as environmental considerations began to change both engine design and gasoline characteristics.

This review collects information about all three members of the triumvirate in one place. The major focus is gasoline – its performance, characteristics, refining and testing, and safe use. Significant space is also devoted to the operation of modern engines and to the impact of environmental regulations on both engines and fuels. Numerous cross-references emphasize how interconnected these topics are. We hope readers will find the review a source of valuable information, whether they read it from cover to cover or focus on an area of interest.

**Please note:** The information in this review may be superseded by new regulations or advances in fuel or engine technology.

<sup>1</sup> Both the names *coal oil* and *kerosene* were holdovers from the previous decades when lamp oil was distilled from coal. Kerosene, a corruption of the Greek words for wax and oil, was one American company's brand name for coal oil.

<sup>2</sup> Petroleum Panorama, *The Oil and Gas Journal*, 57 (5), January 28, 1959.





# 1 • Gasoline and Driving Performance

---

When drivers think about gasoline, their thoughts rarely go beyond filling up or checking prices. Because gasoline almost always performs well, drivers forget what a sophisticated product it is. More thought would reveal a demanding set of performance expectations:

- An engine that starts easily when cold, warms up rapidly, and runs smoothly under all conditions.
- An engine that delivers adequate power without knocking.
- A vehicle that provides good fuel economy and generates low emissions.
- A gasoline that does not add to engine deposits or contaminate or corrode a vehicle's fuel system.

Although proper vehicle design and maintenance are necessary, gasoline plays an important role in meeting these expectations.

This chapter discusses how gasoline's characteristics affect driving performance.

## VOLATILITY

*Driveability* describes how an engine starts, warms up, and runs. It is the assessment of a vehicle's response to the use of its accelerator relative to what a driver expects. Driveability problems include hard starting, backfiring, rough idling, poor throttle response, and stalling (at idle, under load, or when decelerating).

The key gasoline characteristic for good driveability is *volatility* – a gasoline's tendency to vaporize. Volatility is important because liquids and solids don't burn; only vapors burn. When a liquid appears to be burning, actually it is the invisible vapor above its surface that is burning. This rule holds true in the combustion chamber of an engine; gasoline must be vaporized before it can burn. For winter weather, gasoline blenders formulate gasoline to vaporize easily. Gasoline that vaporizes easily allows a cold engine to start quickly and warm up smoothly. Warm-weather gasoline is blended to vaporize less easily to prevent engine vapor lock and other hot fuel handling problems and to control evaporative emissions that contribute to air pollution.

It is important to note that there is no single best volatility for gasoline. Volatility must be adjusted for the altitude and seasonal temperature of the location where the gasoline will be used. Later, this chapter will explain how gasoline specifications address this requirement.

Three properties are used to measure gasoline volatility in the United States: *vapor pressure*, *distillation profile*, and *vapor-liquid ratio*. A fourth property, *driveability index*, is calculated from the distillation profile. Instead of a vapor-liquid ratio, a *vapor lock index* is used outside the U.S. to control hot fuel handling problems.

## Vapor Pressure

For those materials that can exist as a vapor, some vapor is present even when the material is in its liquid or solid state. A material's vapor pressure is the pressure exerted by the vapor when the vapor is in equilibrium with the liquid or solid. The vapor pressure of gasoline is measured at a temperature of 37.8°C (100°F) and a pressure of 1 atmosphere. Vapor pressure is expressed as kilopascals (kPa) or pounds per square inch (psi).

## Vapor Pressure

With respect to gasoline, vapor pressure (VP) is the single most important property for cold-start and warm-up driveability. (*Cold-start* means that the engine is at ambient temperature, not that the ambient temperature is cold.) When gasoline vapor pressure is low, an engine may have to be cranked a long time before it starts. When vapor pressure is extremely low, an engine may not start at all. Engines with port fuel injection (see page 66) appear to start more readily with low vapor pressure fuel than do carbureted engines. Vapor pressure varies with the season; the normal range is 48.2 kPa to 103 kPa (7 psi to 15 psi). Higher values of vapor pressure generally result in better cold-start performance, but lower values are better to prevent vapor lock and other hot fuel handling problems.

## Distillation Profile

Gasoline is a mixture of hundreds of hydrocarbons, many of which have different boiling points. Thus gasoline boils, or distills, over a range of temperatures, unlike a pure compound; water, for instance, boils at a single temperature. A distillation profile, or *distillation curve*, is the set of increasing temperatures at which gasoline evaporates for a fixed series of increasing volume percentages (5 percent, 10 percent, 20 percent, 30 percent and so on) under specific conditions (see page 48). Alternatively, the profile may be the set of increasing evaporation volume percentages for a fixed series of increasing temperatures. Figure 1.1 shows the 2008 U.S. average distillation profiles of conventional summer and winter gasolines. A distillation profile is also shown for a summer reformulated gasoline (RFG) containing ethanol.

Figure 1.1

### Typical Distillation Profiles of Summer and Winter Gasolines (ASTM D86)

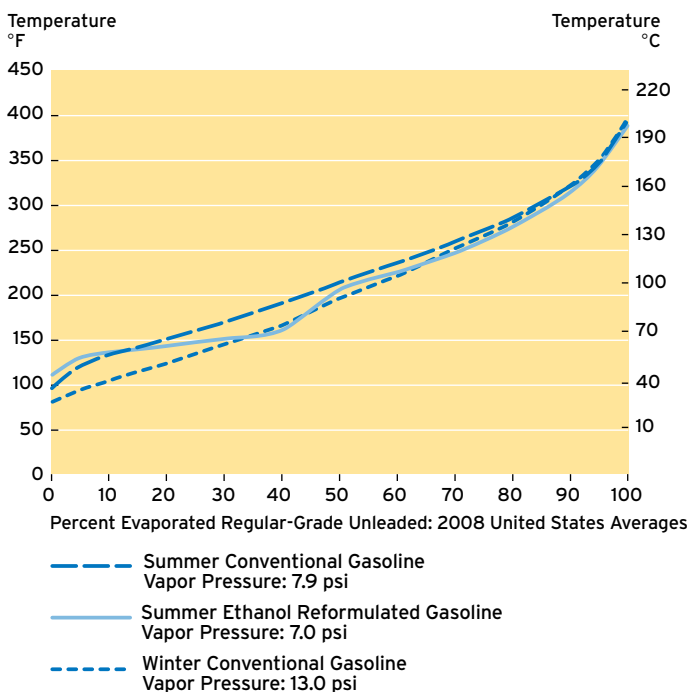

Various ranges of a distillation profile correlate with specific aspects of gasoline performance.

Front-end volatility is adjusted to provide:

- Easy cold starting.
- Easy hot starting.
- Freedom from vapor lock or other hot fuel handling problems.
- Low evaporation and running-loss emissions.

Midrange volatility is adjusted to provide:

- Rapid warm-up and smooth running.
- Good short-trip fuel economy.
- Good power and acceleration.
- Protection against carburetor icing and hot-stalling.

Tail-end volatility is adjusted to provide:

- Good fuel economy after engine warm-up.
- Freedom from engine deposits.
- Minimal fuel dilution of crankcase oil.
- Minimal volatile organic compound (VOC) exhaust emissions (see page 17).

## Gasoline and Driving Performance

Figure 1.2 illustrates these correlations. The temperature range is approximate; the exact range depends on the conditions that exist in the location where a vehicle is driven.

### Vapor-Liquid Ratio

The vapor-locking tendency of a gasoline is influenced both by the temperatures at the front end of its distillation profile and by its vapor pressure. However, the property that correlates best with vapor lock and other hot fuel handling problems (hard starting or no starting after a hot soak, and poor throttle response) is the temperature at which a gasoline forms a vapor-liquid ratio of 20 (V/L = 20). This is the temperature at which a gasoline exists as 20 volumes of vapor in equilibrium with one volume of liquid at atmospheric pressure. The temperature for a V/L = 20 varies with the season; the normal range is 35°C to 60°C (95°F to 140°F). Gasolines with higher values provide greater protection against vapor lock and hot fuel handling problems. This correlation was developed for vehicles with suction-type fuel pumps and carburetors. Tests in later-model, fuel-injected cars with pressurized fuel systems have shown a good correlation for hydrocarbon-only gasoline. A downward adjustment to the measured value under some circumstances is needed to predict the performance of ethanol blends.

### Vapor Lock Index

Outside the U.S., vapor lock index (VLI) is used to control vapor lock and other hot fuel handling problems. VLI is calculated using vapor pressure in kPa and distillation profile percent evaporated at 70°C (158°F), as follows:

$$\text{VLI} = 10(\text{VP}) + 7(\text{E}70)$$

VLI varies with the season. The normal range is 800 to 1,250. Lower values provide greater protection against vapor lock and hot fuel handling problems.

### Driveability Index

Although each range of a distillation profile is important, the gasoline represented by an entire profile is what the engine must distribute, vaporize, and burn. To predict a fuel's cold-start and warm-up driveability, a driveability index (DI) has been developed using the temperatures for the evaporated percentages of 10 percent (T10), 50 percent (T50), and 90 percent (T90) and ethanol content:

$$\text{DI}^{\circ}\text{C} = 1.5(\text{T}10) + 3.0(\text{T}50) + (\text{T}90) + 1.33 (\text{ethanol volume percent})$$

$$\text{DI}^{\circ}\text{F} = 1.5(\text{T}10) + 3.0(\text{T}50) + (\text{T}90) + 2.4 (\text{ethanol volume percent})$$

The DI varies with gasoline grade and season. In the U.S., the normal range of DI°C is 375°C to 610°C-derived (DI°F is 850°F to 1,275°F-derived). In other parts of the world, the range may be narrower; for example, in the Asia-Pacific region the range of DI°C is 460°C to 580°C-derived (DI°F is 1,000°F to 1,200°F-derived). Lower values of DI generally result in better cold-start and warm-up performance, but once good driveability is achieved, there is no benefit to further lowering the DI.

Figure 1.2

### Correlation of Distillation Profile Ranges (ASTM D86) with Gasoline Performance

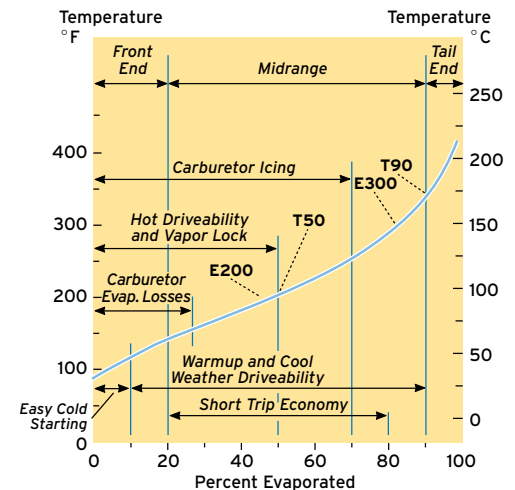

### Vapor Lock and Hot Fuel Handling Problems

Vapor lock and hot fuel handling problems occur when excessive gasoline vapor accumulates somewhere in the fuel system of a vehicle and reduces or interrupts the fuel supply to the engine. This may take place in the fuel pump, the fuel line, the carburetor, or the fuel injector. When the fuel supply is reduced, the air-fuel ratio becomes too fuel-lean (too much air for the amount of fuel), which may cause loss of power, surging, or back-firing. When the fuel supply is interrupted, the engine stops and may be difficult to restart until the fuel system has cooled and the vapor has recondensed. After a hot soak (engine shutdown), it may be difficult to start the engine if too much vapor has formed in the fuel system.

Overheated fuel or overly volatile fuel is the main cause of vapor lock. Fuel temperature depends on several factors: the ambient temperature, how hard the vehicle is working, how well the fuel system is isolated from the heat of the engine, and how effectively the fuel system is cooled.

### Carburetor Icing

Carburetor icing occurs when intake air is chilled below the freezing point of water by evaporation of gasoline in the carburetor. Ice forms on the throttle blade and in the venturi and can interrupt carburetion, causing an engine to stall.

Icing can be acute when the air is moist (70 percent or higher relative humidity) and the ambient temperature is between 2°C and 13°C (35°F and 55°F). These weather conditions are common during the fall, winter, and spring in many parts of the U.S., and they can last well into the summer in some coastal regions. Carburetor icing is not a problem when the intake air temperature is below freezing because the air is too dry.

The extent of carburetor icing does not depend on weather alone. It also involves carburetor and vehicle design and the mechanical condition of the engine, in particular, those components that affect warm-up time, such as thermostats, automatic chokes, intake air heaters, and heat risers. Icing also involves gasoline volatility. The 70 percent evaporated temperature in the distillation profile is a good index to measure the tendency of a gasoline to cause carburetor icing; the lower this temperature, the more severe the icing.

Carburetor icing is not as big a problem as it used to be. For emission control reasons, most carbureted engines built since the late 1960s have been equipped with intake air-heating systems that generally eliminate carburetor icing. Today the problem is minimal because fuel-injected vehicles have replaced most carbureted vehicles.

The equation was originally developed using data for conventional gasolines in carbureted vehicles. Subsequent testing has shown the equation to be applicable to conventional gasoline used in later-model, fuel-injected engines. However, for ethanol blends, an upward adjustment has been adopted by ASTM International, as shown in the DI equations on the previous page, to correlate with actual vehicle driveability performance.

### Volatility Specifications

The gasoline specification ASTM D4814 (see page 45) controls the volatility of gasoline by setting limits for vapor pressure, distillation temperatures at 10 percent, 50 percent, and 90 percent evaporated points and end point, driveability index, and vapor-liquid ratio properties. The specification employs six vapor pressure/distillation classes (Table 1.1a) and six vapor-liquid ratio classes (Table 1.1b). The specification, except during transition months, assigns one vapor pressure/distillation class and one vapor-liquid ratio

Table 1.1a

ASTM D4814 Vapor Pressure and Distillation Class Requirements

Vapor Pressure/ Distillation Class	Vapor Pressure, kPa (psi) max	Distillation Temperature, °C (°F)				Driveability Index, max Derived °C (°F)
		10 vol% Evap., max	50 vol% Evap., <sup>1</sup> min – max	90 vol% Evap., max	End Point, max	
AA	54 (7.8)	70 (158)	77-121 (170-250)	190 (374)	225 (437)	597 (1250)
A	62 (9.0)	70 (158)	77-121 (170-250)	190 (374)	225 (437)	597 (1250)
B	69 (10.0)	65 (149)	77-118 (170-245)	190 (374)	225 (437)	591 (1240)
C	79 (11.5)	60 (140)	77-116 (170-240)	185 (365)	225 (437)	586 (1230)
D	93 (13.5)	55 (131)	77-113 <sup>2</sup> (170-235)	185 (365)	225 (437)	580 (1220)
E	103 (15.0)	50 (122)	77-110 <sup>2</sup> (170-230)	185 (365)	225 (437)	569 (1200)

<sup>1</sup> For 1-10 vol% ethanol blends, T50 minimum is 66°C (150°F).

<sup>2</sup> For classes D and E, T50 minimum is 66°C (150°F) for gasoline that will not be blended with ethanol. Such gasoline is not suitable for blending with ethanol.

Table 1.1b

ASTM D4814 Vapor Lock Protection Class Requirements

Vapor Lock Protection Class	Temperature, °C (°F) for a Vapor-Liquid Ratio of 20, min
1	60 (140)
2	56 (133)
3	51 (124)
4	47 (116)
5	41 (105)
6	35 (95)



class each month to each geographical area (state or portion of a state) in the U.S. based on altitude and the expected ambient temperature range.

Gasoline volatility affects not only a vehicle's driveability but also its VOC emissions (from evaporation and exhaust, see page 20). To help control the aspect of air quality affected by hydrocarbon emissions, the U.S. government and some states limit gasoline volatility by law. ASTM International incorporates volatility (vapor pressure) regulations from the U.S. EPA and state implementation plans (SIPs) into its gasoline specifications as such controls are promulgated and approved.

Fluctuating volatility requirements make gasoline manufacture and distribution a complex process. A refiner producing gasoline for a multistate area may have to make gasolines with several different volatilities and change the volatility from month to month. Each gasoline must be shipped separately to the appropriate location.

The Comité Européen de Normalisation (CEN), also known as the European Committee for Standardization, controls petrol volatility through *EN 228 Automotive fuels – Unleaded petrol – Requirements and test methods*. The specification sets limits on vapor pressure, distillation (percent evaporated at three temperatures), final boiling point (FBP), distillation residue, and VLI. In addition, it employs six volatility classes (Table 1.2) that are assigned by country for winter, summer, and transition periods.

Other areas of the world use specifications developed by ASTM International or CEN. Alternatively, some countries develop their own volatility specifications, which may stipulate a single, year-round volatility class, winter and summer classes, or systems similar to those of ASTM International or CEN.

Table 1.2

EN 228 Volatility Class Requirements

Volatility	Unit	Class A	Class B	Class C/C1	Class D/D1	Class E/E1	Class F/F1
Vapor Pressure	kPa	45.0 - 60.0	45.0 - 70.0	50.0 - 80.0	60.0 - 90.0	65.0 - 95.0	70.0 - 100.0
	psi	6.5 - 8.7	6.5 - 10.2	7.3 - 11.6	8.7 - 13.1	9.4 - 13.8	10.2 - 14.5
% Evaporated at 70°C (158°F), E70	vol %	20.0 - 48.0	20.0 - 48.0	22.0 - 50.0	22.0 - 50.0	22.0 - 50.0	22.0 - 50.0
% Evaporated at 100°C (212°F), E100	vol %	46.0 - 71.0	46.0 - 71.0	46.0 - 71.0	46.0 - 71.0	46.0 - 71.0	46.0 - 71.0
% Evaporated at 150°C (302°F), E150	vol %, min	75.0	75.0	75.0	75.0	75.0	75.0
Final Boiling Point	°C, max	210	210	210	210	210	210
	°F, max	410	410	410	410	410	410
Distillation Residue	vol %, max	2	2	2	2	2	2
VLI (10 VP + 7 E70)	Index, max	-	-	C(-) C1(1050)	D(-) D1(1150)	E(-) E1(1200)	F(-) F1(1250)
VLI (68.95 VP <sub>psi</sub> + 7 E158°F)	Index, max	-	-	C(-) C1(1050)	D(-) D1(1150)	E(-) E1(1200)	F(-) F1(1250)

### Knocking

*Engine knocking or pinging is the sound of abnormal combustion. It is also known as spark knock. Normal combustion in a spark-ignition internal combustion engine is initiated by a spark. Within a combustion chamber, the flame front of a spark fans out from a spark plug and travels across the chamber rapidly and smoothly until almost all fuel residing in the chamber is consumed. When combustion is abnormal, the last part of the unburned air-fuel mixture ignites spontaneously (autoignites) and burns very rapidly, causing the pressure in the cylinder to rise rapidly. This creates the characteristic knocking or pinging sound.*

*Occasional light knocking doesn't usually hurt an engine. But conditions that create heavy or prolonged knocking can result in:*

*(continued on next page)*

(continued from previous page)

- Objectionable noise
- Loss of power
- Overheating of engine parts
- Knock-induced surface ignition
- Engine damage

Knock occurs because the gasoline burning in an engine has an antiknock rating (octane number) below the anti-knock requirement of the engine at that moment. Generally, the situation involves high-load conditions, such as hard acceleration or climbing a grade.

#### **Other Abnormal Combustion Phenomena**

Other abnormal combustion phenomena can occur in addition to knocking. Surface ignition involves the ignition of the air-fuel mixture by a hot spot rather than a spark. Potential ignition sources include glowing combustion chamber deposits, sharp edges or burrs in the combustion chamber, and an overheated spark plug electrode.

Heavy, prolonged spark knock can generate hot spots that produce surface ignition. A hot spot can ignite a portion of the air-fuel mixture before the mixture would normally start to burn. This may occur either before or after spark ignition. Surface ignition before a spark is called preignition. Surface ignition after a spark is called post-ignition. When preignition occurs, ignition timing is lost and upward movement of the piston is opposed by the high pressure generated by early combustion. This results in engine roughness, power loss, and severe localized heating of the piston crown. If it is prolonged, the localized heating can burn a hole in the piston.

(continued on next page)

## **ANTIKNOCK PERFORMANCE**

Knock-free engine performance is as important as good driveability. *Octane number* is a measure of a gasoline's antiknock performance, that is, a gasoline's ability to resist knocking as it burns in the combustion chamber. There are two laboratory test methods used to measure the octane number of a gasoline (see page 47). One method yields the *Research octane number (RON)*; the other results in the *Motor octane number (MON)*. RON correlates best low-speed, mild-knocking conditions; MON correlates best high-speed and high-temperature knocking conditions and with part-throttle operation. For a given gasoline, RON is always greater than MON. The difference between the two indicates the sensitivity of the gasoline to changes in operating conditions. The larger the difference, the more sensitive the gasoline.

RON and MON are measured in a single-cylinder laboratory engine, so they do not completely predict antiknock performance in multicylinder engines. The Modified Uniontown procedure (see page 48) involves using an actual vehicle to measure the antiknock performance of a gasoline. The resulting value is called *Road octane number (RdON)*. Because vehicle testing is more complex than laboratory testing, there have been several attempts to predict RdON from RON and MON. The equations take the following form:

$$\text{RdON} = a(\text{RON}) + b(\text{MON}) + c$$

A good approximation for RdON is  $a = b = 0.5$  and  $c = 0$ , yielding  $(\text{RON} + \text{MON})/2$ , commonly written  $(R + M)/2$ . This is called the *antiknock index (AKI)*. The U.S. Federal Trade Commission requires dispensing pumps to be labeled (posted) with the AKI of the gasoline they dispense.<sup>1</sup> In addition, owner's manuals for vehicles in the U.S. must specify recommended fuel by AKI.<sup>2</sup>  $(R + M)/2$  is voluntarily posted in Canada.

Neither the AKI nor any of the other single-value indices that have been developed forecast the performance of a gasoline in all vehicles. In some vehicles, performance correlates better with either RON or MON alone rather than with a combination of the two. Also, for a given vehicle, the correlation can vary with driving conditions.<sup>3</sup>

As the formula indicates, gasolines with the same AKI can have different RONs and MONs. This may explain why a vehicle knocks while running on certain brands of gasoline or even between fill-ups of the same brand. Of course, for a comparison to be valid, a vehicle must be operated under identical conditions, which is not easy for the typical driver to arrange.

<sup>1</sup> The gasoline being dispensed must have an antiknock index equal to or greater than the posted value. Rounding the number upward is not permitted.

<sup>2</sup> Older owner's manuals of some foreign cars specify RON; some more recent ones specify both RON and AKI.

<sup>3</sup> See Table 1.3 on page 8 for the variables that affect an engine's octane number requirement.

Generally, three grades of unleaded gasoline with different AKIs are available in the U.S.: regular, midgrade, and premium. At sea level, the posted AKI for regular grade is usually 87; for midgrade, 89. The AKI of premium grade varies, ranging from 91 to 94.

The posted AKIs are lower in the Rocky Mountain states. *Altitude gasolines* have historically provided the same antiknock performance as higher-AKI gasolines at sea level. The octane requirement of older-model engines decreases as air pressure (barometric pressure) decreases. Barometric pressure is lower at higher elevations.

Since 1984, vehicles have been equipped with more sophisticated control systems, including sensors to measure and engine management computers to adjust for changes in air temperature and barometric pressure (see page 69). These vehicles are designed to have the same AKI requirement at all elevations, and the owner's manuals specify the same AKI gasoline at all elevations.

Outside the U.S. and Canada, when an octane number is posted at a service station, RON is generally used. In these countries, vehicle owner's manuals also specify the minimum octane grade recommended in terms of RON.

It is difficult for a driver to know whether a gasoline has the antiknock performance an engine requires when the engine is equipped with a knock sensor system. These systems, which temporarily retard spark timing to eliminate knocking, are installed on many late-model engines (see page 72). Retarding the spark reduces power and acceleration. The knock sensor responds so quickly that the driver never notices the knock. Loss of power and acceleration will be the only clue that the antiknock quality of the gasoline does not meet the vehicle's octane requirement.

**Using gasoline with an antiknock rating higher than that required to prevent knock or to prevent spark retardation by the knock sensor will not improve a vehicle's performance.**

## OCTANE NUMBER REQUIREMENT

The technical *octane number requirement* (ONR) of an engine is the octane number of a reference fuel that will produce trace knock under the most severe speed and load conditions. *Trace knock* is the knock intensity that is just audible to a trained technician. Customers may or may not be able to detect trace knock, so customer ONR is usually less than the technical ONR. For the remainder of this review, ONR will refer to technical ONR. ONR can be reported as a RON or AKI value.

The ONR of an engine is usually determined for either maximum-throttle or part-throttle acceleration conditions, whichever is the most critical. ONR varies considerably engine to engine, sometimes as much as 10 points among vehicles with the same engine model.

*(continued from previous page)*

*When preignition is caused by a hot spot generated by prolonged, heavy spark knock, it is known as knock-induced preignition. It has the same adverse effect on engine operation as preignition from other sources. Knock-induced preignition is the most damaging side effect of spark knock.*

*Post-ignition reduces combustion time, and loss of combustion control can cause knock, engine roughness, and reduced power output. The extent of the effect of post-ignition depends on its location in a combustion chamber and the time in the combustion cycle that it occurs.*

*Run-on occurs when the engine continues to run after a vehicle's ignition switch is turned off. It also is referred to as after-running or dieseling. The engine runs noisily, and the exhaust smells bad. Run-on usually is caused by compression-ignition, when a combustion chamber is hot enough to autoignite the air-fuel mixture; however, it also can be caused by surface ignition. The incidence of run-on is decreased or eliminated as the octane quality, especially the RON, of a gasoline is increased. Another important run-on factor is idle speed. This is why many carbureted engines are equipped with an idle stop (anti-dieseling) solenoid. Run-on is not a problem with modern fuel-injected engines because fuel cannot be delivered to combustion chambers when the ignition switch is turned off.*

Table 1.3

Average Effect of Some Variables on Engine Octane Number Requirement

Variable	Change in Variable	Change in ONR, (AKI Number)
Compression Ratio	+1 <sup>1</sup>	+3 to +5
Air-Fuel Ratio	+1 <sup>2</sup>	+2
Spark Advance	+1°	+0.5 to +0.8
Ambient Temperature	+6°C (+10°F) <sup>3</sup>	+0.5
Absolute Humidity	+1.4 g/kg (+10 grains/lb)	-0.3
Altitude	+300 m (+1,000 ft)	-1.5 <sup>4</sup>
Combustion Chamber Deposits	-	+1 to +13 <sup>5</sup>

<sup>1</sup> In range 8:1 to 11:1.  
<sup>2</sup> Fuel leaning.  
<sup>3</sup> In range 71°C (160°F) to 82°C (180°F).  
<sup>4</sup> For newer engines the change is almost zero because the ECM leans the air-fuel mixture and advances the spark timing as altitude increases.  
<sup>5</sup> Change depends on engine design, fuel, lubricant, and operating conditions.

Figure 1.3 Relationship Between Fleet Average Fuel Economy and Heating Value

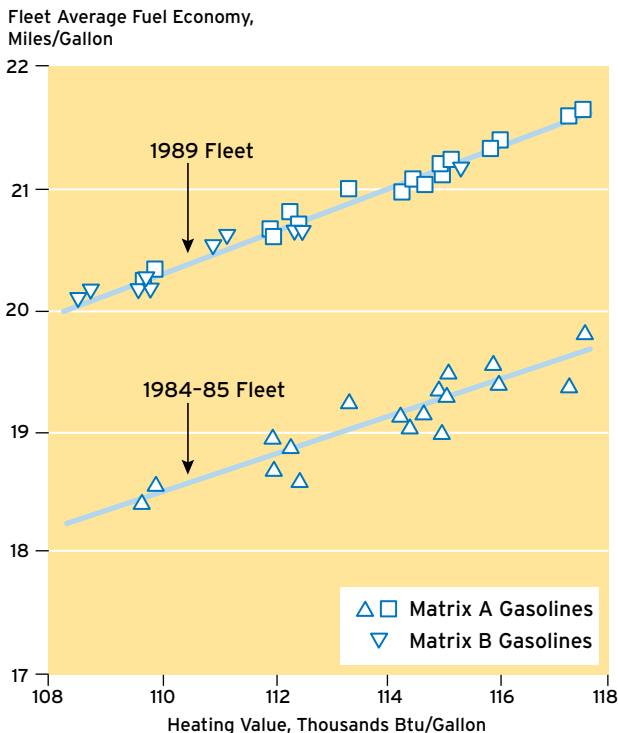

Reprinted with permission from SAE Paper No. 930138 ©1993 Society of Automotive Engineers, Inc.

The ONR of an engine is influenced by its operating conditions. The effects of some of the more significant of these are listed in Table 1.3. Mechanical and electrical ignition problems can increase ONR. These would include a malfunctioning exhaust gas recirculation (EGR) valve and problems with spark timing.

With late-model vehicles that use engine control module (ECM) systems and knock sensors, the traditional definition of ONR may no longer apply since the knock sensor systems are calibrated to either nearly or completely eliminate audible knock. Work is being done to redefine the ONR for modern vehicles based on a measure of acceleration performance.

When an engine is brand-new, its ONR is determined by its design and manufacture. Generally, an engine will not knock when operated on a gasoline with the AKI or RON recommended by the automobile manufacturer. However, an engine’s ONR can increase dramatically during the first several thousand kilometers (miles) of a vehicle’s use. This effect, called *octane requirement increase (ORI)*, is caused by the buildup of carbonaceous deposits in the engine’s combustion chambers (see page 78).

If an engine is equipped with a knock sensor, a slight loss of power may occur during heavy accelerations. This happens if the ORI results in an octane number requirement that exceeds the AKI of the gasoline being used.

## POWER

The power an engine can produce depends on its design. In general, the more air an engine can process, the more power it can produce. Major design considerations for power are engine displacement, compression ratio, and the presence of a supercharger or turbocharger. Other factors affecting power are the number of valves per cylinder, valve timing, and spark timing (see Chapter 5, “Gasoline Engines and Selected Systems”). Different grades of gasoline may have small differences in heating value (see sidebar definition), but they provide comparable power in a given engine as long as their antiknock performance meets the engine’s requirement.



## FUEL ECONOMY

Fuel economy in the U.S. is usually expressed as the number of miles traveled on one gallon of gasoline (*miles per gallon*, or *mpg*). Many drivers calculate vehicle mpg by counting the miles driven between fill-ups. Outside the U.S., fuel economy is usually expressed as liters per 100 kilometers (L/100 km). Because controlling influencing factors is difficult and often impossible, driving on the road is not a reliable way to determine how fuel economy is affected by gasoline composition. A more accurate determination is possible under controlled laboratory conditions. A vehicle is mounted on a chassis dynamometer in a temperature-controlled space and driven through a specified operating cycle. The weight or volume of the gasoline consumed during the cycle may be measured or the fuel economy may be calculated from the weight fraction of carbon compounds in the vehicle's exhaust.

Figure 1.3 shows that the average fuel economies of two fleets of vehicles are proportional to the heating values of the gasolines tested.<sup>4</sup> This is the relationship predicted by combustion theory. In the test, the newer fleet was composed of 1989 model-year cars and the older fleet included 1984–1985 model-year cars. The test involved two different sets of gasolines (Matrix A and Matrix B) that varied in aromatics content, olefins content, oxygen content, oxygenate type, and several other properties (see page 31). Results show that heating values can be used as surrogates for actual fuel economy measurements when considering the effect of gasoline composition on fuel economy.

Conventional fuels always have varied in heating value. One cause is the formulation differences among batches and among refiners. A survey of 1990–1991 conventional gasolines found that the heating value of summer gasolines varied over an 8 percent range.<sup>5</sup> Heating value also varies by grade and by season. On average, the heating value of premium-grade gasoline is about 0.7 percent higher than regular grade because premium grade, in general, contains more aromatic hydrocarbons, the class of hydrocarbons with the highest densities. The heating value of winter gasoline is about 1.5 percent lower than summer gasoline because winter gasoline contains more volatile, less dense hydrocarbons.

Oxygenated gasolines (see page 53) have lower heating values because the heating values of the oxygenate components are lower than those of the hydrocarbons they displace. The percentage decrease in heating value is close to the mass percent oxygen in the gasoline. For example, in keeping with federal regulations, gasoline in carbon monoxide nonattainment areas in the U.S. is oxygenated to a minimum of 2.7 mass percent oxygen during four or

### Heating Value

*The heating value (also referred to as energy content) of gasoline is its heat of combustion, or the heat released when a known quantity of fuel is burned under specific conditions. In the U.S., heating value is usually expressed as British thermal units (Btus) per pound or per gallon at 60°F. The international metric (SI) units are joules per kilogram (J/kg) or joules per cubic meter (J/m<sup>3</sup>) at 15°C. For gross heating value, the water produced by the combustion is assumed to be recondensed to a liquid. For the lower net heating value, the water is assumed to remain a gas. All engines exhaust water as a gas, so net heating value is appropriate for comparing different fuels.*

*Because gasoline is sold by volume, it is customary to express gasoline heating values per unit volume, specifically, Btu per gallon (or J/m<sup>3</sup>). This is the value that correlates with fuel economy because fuel economy is expressed per unit volume (mpg) in the U.S. or volume per distance (L/100 km) in much of the rest of the world.*

*The densities of the hydrocarbons in gasoline vary over a much wider range from their heating values per unit weight. Consequently, compositional changes that result in density changes are accompanied by changes in heating value per unit volume. If the density of a conventional gasoline decreases, its heating value per unit volume also decreases.*

*(continued on next page)*

<sup>4</sup> Hochhauser, Albert M., et al., *Fuel Composition Effects on Automotive Fuel Economy – Auto/Oil Air Quality Improvement Research Program*, Paper No. 930138, Society of Automotive Engineers, Warrendale, Pa., March 1993.

<sup>5</sup> California Air Resources Board, *Survey of California Gasolines*, Sacramento, Ca., 1991.

---

*(continued from previous page)*

*Adding oxygenates to conventional gasoline also decreases heating value. Oxygenates have lower heating values than hydrocarbons on both unit-weight and unit-volume bases. The amount of decrease depends on the amounts and identities of the oxygenates.*

five winter months.<sup>6</sup> The heating value of the oxygenated product is about 2.7 mass percent lower than that of conventional gasoline. In addition, federal RFG and California Phase 3 RFG in federal RFG areas are typically oxygenated year-round to an average oxygen content of about 2 mass percent. The resulting heating values are about 2 percent lower than that of conventional gasoline. California Phase 3 RFG also has limits on distillation temperatures and aromatics content, which has the secondary effect of lowering the density of the fuel. These limits reduce heating value by about another 1 percent.

The gasolines that produced the results displayed in Figure 1.3 were specially formulated to span a wide range of compositions. The compositional variations were much greater than those separating conventional and reformulated commercial gasolines. Thus, the results provide solid evidence that RFG does not exert an unusual effect on fuel economy. Individual drivers have reported decreases of 10 percent, 15 percent, and even 20 percent in fuel economy when they began using RFG. Not surprisingly, many of the claims are anecdotal. Most drivers do not keep continuous fuel-economy records, so they don't have a meaningful fuel-economy baseline for the gasoline they previously used. Even with a baseline, a fuel-economy value based on the consumption of a single tank of gasoline can be misleading. Drivers interested in fuel economy should average results over several tanks of gasoline or, better yet, over several months of driving.

### Factors Affecting Fuel Economy

Fuel economy is affected by a vehicle's size, weight, aerodynamics, fuel delivery system, engine design, and transmission type. These factors remain constant for a specific vehicle.

There are, however, many variable factors that influence fuel economy. As mentioned, the heating value of gasoline is one. Weather conditions, air conditioner use, road conditions, the route driven, traffic, driving speed, and driving style are others. Fuel economy is also affected by the mechanical condition of the car, including the engine tune, wheel alignment, and tire pressure. Some of these non-gasoline factors have the potential to cause substantial changes in fuel economy. Table 1.4 lists average and maximum effects published by the U.S. Environmental Protection Agency (EPA).

Carbonaceous engine deposits can build up over time and degrade fuel economy and other performance attributes, but these problems can be reduced with the use of deposit control additives. This subject is discussed in detail in Chapter 6, "Gasoline Vehicles – Deposit Control."

Winter-related factors can combine to lower fuel economy up to 20 percent compared to summer factors. These include rain or snow on the road, which increases tire resistance. In addition, for safety a driver may need to slow down to a less fuel-efficient speed. In cold weather, a richer air-fuel mixture is required to start and warm up an engine. Much of the

<sup>6</sup> *Nonattainment area* is a U.S. EPA designation for an area where an air pollutant, carbon monoxide in this case, exceeds the limit established by the National Ambient Air Quality Standards more often than allowed.

warm-up is done at idle because of the need to defog or defrost windows. Also, in many vehicles, the air conditioner is operated to assist defogging. More energy is required to overcome the resistance created by the higher viscosities of cold lubricants, including engine oil, transmission fluid, and differential lubricant.

Short trips are worse for fuel economy than long trips because a cold engine uses more fuel than a warm engine and requires more energy to overcome the resistance of cold lubricants.

Traffic jams and bumper-to-bumper driving exact a heavy toll on fuel economy.

### Fuel Economy Road Test

The results of a Wisconsin on-road fuel economy test demonstrate that some of the above factors can have a much bigger effect on fuel economy than a small percentage change in gasoline heating value.<sup>7</sup>

Table 1.4

**Fuel Economy Reduction Estimates by Factor**

Factor	Conditions	Percent Reduction in Fuel Economy	
		Average	Maximum
Temperature	20°F vs. 77°F	5.3	13
Idling/Warmup	Winter vs. summer	Variable with driver	20
Defroster	Extreme use	Analogous to air conditioning on some vehicles	
Head Wind	20 mph	2.3	6
Uphill Driving	7% grade	1.9	25
Poor Road Conditions	Gravel, curves, slush, snow, etc.	4.3	50
Congested Traffic	20 mph vs. 27 mph average speed	10.6	15
Highway Speed	70 mph vs. 55 mph	N/A	25
Acceleration Rate	"Hard" vs. "easy"	11.8	20
Wheel Alignment	0.5 inch	<1	10
Tire Type	Non-radial vs. radial	<1	4
Tire Pressure	15 psi vs. 26 psi	3.3	6
Air Conditioning	Extreme heat	21	N/A
Windows	Open vs. closed	Unknown, but likely small	

Office of Mobile Sources, U.S. EPA, *Fuel Economy Impact Analysis of RFG*, August 1995 (Document EPA 420-F095-003).

<sup>7</sup> *On-Road Study of the Effects of Reformulated Gasoline on Motor Vehicle Fuel Economy in Southeastern Wisconsin*, Wisconsin Department of Natural Resources, Madison, Wis., March 1995.

---

The test was designed to minimize all factors affecting fuel economy except gasoline composition. Fueled with various gasolines, vehicles were driven over the same route of 100 miles (161 kilometers) of urban and suburban roads. The fuel economy of each vehicle was measured four times for each gasoline: once in the morning and afternoon of the same day and again in the morning and afternoon of one day a week later. In some cases, a vehicle was driven by the same driver both days. Other vehicles were driven by more than one driver. When the results for the two weeks were compared, most of the fuel economies in the second week were lower. The differences were greater than 10 percent for a quarter of the car-fuel combinations. Two factors that probably contributed to the week-to-week differences were driver changes and a weather change. Ambient temperatures were lower in the second week; on some days, noontime temperatures were as much as 17°C (30°F) cooler than the average noontime temperature of the preceding week.

The gasolines used in the Wisconsin test were commercial gasolines, either a conventional gasoline or a federal RFG oxygenated with methyl tertiary butyl ether (MTBE), ethyl tertiary butyl ether (ETBE), or ethanol (EtOH). When the results for all the road tests of all the vehicles were combined, the average fuel economy of the three oxygenated federal RFGs was 2.8 percent lower than the average fuel economy of the conventional gasoline. This value was much less than the 10 percent week-to-week difference for some of the car-fuel combinations but within the range predicted by the differences in the gasolines' heating values.

## **OTHER PERFORMANCE FACTORS**

Many gasolines available around the world contain oxygenates. In engines without closed-loop feedback systems, oxygenated gasoline leans the air-fuel mixture. Fuel leaning can cause some degradation in driveability, depending on an engine's calibration (see page 57).

Without fuel additives, deposits form throughout an engine's intake system, including in the fuel injectors, carburetor, intake manifold, and intake ports and on the intake valves. Deposits can be very deleterious to engine performance, degrading driveability, decreasing power and fuel economy, and increasing emissions.



# 2 • Gasoline and Air Quality

Today, we commonly discuss gasoline or gasoline-powered vehicles and their impact on air quality. A number of metropolitan areas in the U.S. fail to meet one or more federal air quality standards. In some of these areas, on-road vehicles are responsible for more than half of the emissions that either primarily or secondarily cause violations of air quality standards. Other major metropolitan areas throughout the world also are experiencing serious air pollution problems.

This chapter explains who regulates emissions and how and why they do it. It also explains which emissions come from vehicles and how those emissions are formed. Finally, it explains how emissions are affected by gasoline characteristics and how gasoline is being reformulated to help reduce emissions.

The explanations are complicated because they involve complex regulations and complex science. As a consequence, keeping this review short and simple is challenging. The numerous acronyms and abbreviations are unavoidable; both government regulation and science use them heavily.

## PROGRESS IN THE UNITED STATES

Are the efforts of adding pollution control systems to vehicles and reformulating gasoline paying off in better air quality? The answer is yes. Urban air quality has improved dramatically over the past 30 years. To illustrate, Figure 2.1 shows the declining trends for the maximum hourly concentrations of three air pollutants, ozone ( $O_3$ ), carbon monoxide (CO), and nitrogen dioxide ( $NO_2$ ), in California. Decreases are not uniform from year to year because of the effect of weather variations on ambient pollutant concentrations.

Improved urban air quality is the result of significant reductions in emissions from various emission source categories such as factories, power plants, consumer products, and automobiles. For example, today a new-model passenger car emits less than 1 percent of the volatile organic compounds (VOCs), less than 5 percent of the carbon monoxide, and only about 7 percent of the oxides of nitrogen ( $NO_x$ ) emitted by a vehicle built before emission controls were implemented. Similarly impressive improvements have been achieved in other emission source categories.

Figure 2.1

Maximum Hourly Pollutant Levels in California 1973-2002

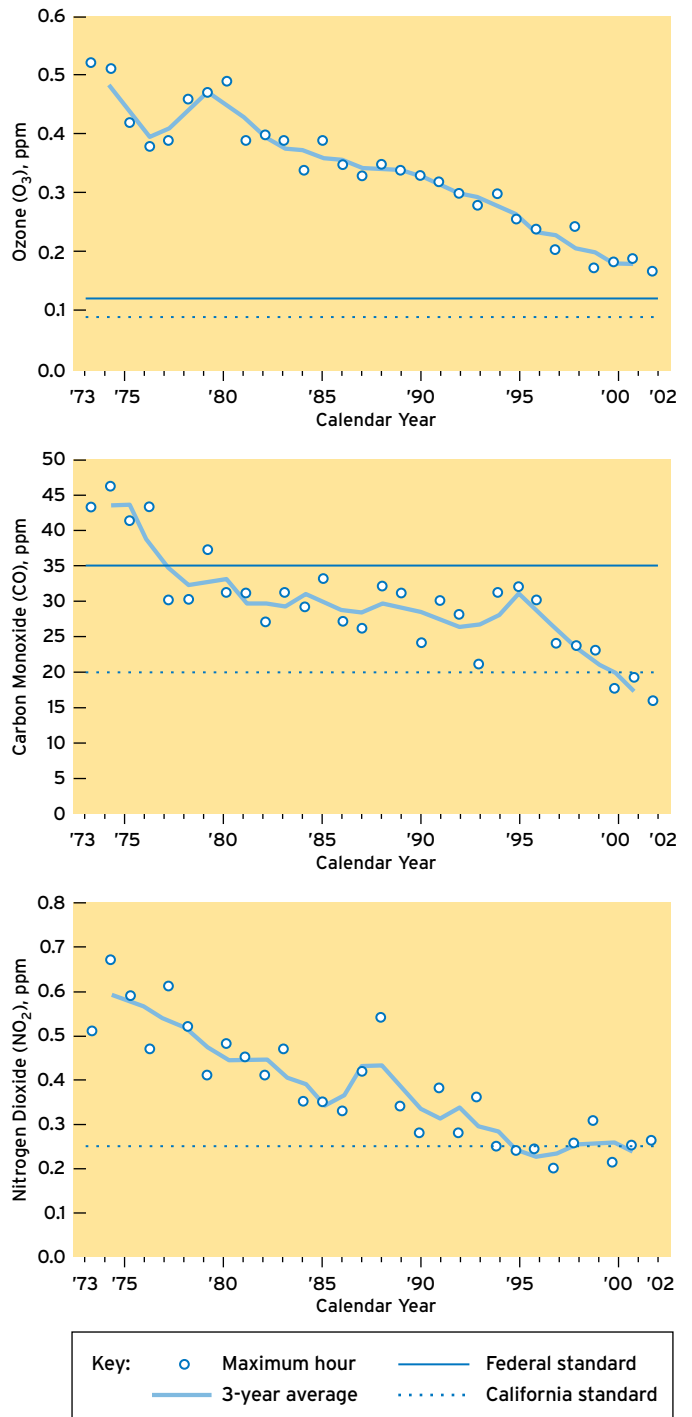

Reprinted with permission from CVS News, July 2003.

### **The Beginning**

*Smog is the common term for the forms of air pollution involving haze and oxidants, such as ozone. Smog was identified as a serious problem in the Los Angeles basin in the 1950s. As university scientists and government health agencies investigated the problem, they found that vehicle emissions were a significant source of smog precursors. Acting on this information, the California legislature established emissions limits for 1966-model cars. Federal legislation to reduce vehicular emissions, as part of a greater air quality program, was initiated with the adoption of the Clean Air Act of 1963. The first federal limits for exhaust emissions from gasoline-powered cars were implemented starting with the 1968 model year.*

The introduction of reformulated gasolines (RFG) also has helped improve air quality. Federal Phase I RFG was introduced in January 1995, Phase II in January 2000. California Phase 2 RFG was required in California in mid-1996, and Phase 3 was required at the end of 2003. Federal Phase II and California Phase 2 and Phase 3 reformulated gasolines are believed to reduce ozone-forming emissions from cars and light trucks by 10 percent to 15 percent. This effect is not apparent in Figure 2.1 because of the year-to-year variability caused by factors such as weather.

### **LEGISLATION**

In the United States, federal legislation regarding air pollution began with the Air Pollution Control Act of 1955. Air pollution *control* legislation was initiated with the Clean Air Act of 1963 and expanded under the Air Quality Act of 1967 and the Clean Air Act of 1970. The 1970 act was amended in 1977 and most recently in 1990.<sup>1</sup> Designed to manage the nation's air quality and to advance regional air pollution prevention and control programs, the act is wide-ranging, addressing a variety of air pollution issues. However, in the area of vehicle emissions, it is restrictive, forbidding states from setting separate vehicle emissions standards. This restriction was included so that auto manufacturers would not have to produce cars with different emission control systems to meet different state standards. The restriction was waived for California. With its more severe smog levels and its long history of working to control vehicle emissions, California is allowed to establish its own regulations for controlling vehicle emissions, subject to federal approval. Under certain circumstances, other states are allowed to require the sale of new vehicles that meet the more stringent California standards.

### **ADMINISTRATION/REGULATION**

Laws are not administered by the body that adopts them. The U.S. Congress or state legislature assigns the administrative responsibility to a governmental agency. In 1970, the National Environmental Policy Act created the U.S. Environmental Protection Agency (EPA) and made it responsible for implementing the requirements of the federal Clean Air Act and its amendments. California's laws covering vehicle emissions are administered by the California Air Resources Board (CARB), which was established by the state legislature in 1967.

While some laws contain a lot of detail, they can't address all the issues surrounding their application in our complex industrial society. The agency administering the law has the responsibility to write regulations that will make the legislative intent a reality. Title 40 of the Code of Federal Regulations (CFR) contains U.S. EPA regulations concerning the protection of the environment.

The states, as Congress intended, do much of the work to carry out the provisions of the federal Clean Air Act and its amendments. State and local air pollution agencies hold hearings, write regulations (based on guidance from the U.S. EPA), issue permits, monitor

<sup>1</sup> "History of the Clean Air Act," U.S. EPA, [http://epa.gov/air/caa/caa\\_history.html](http://epa.gov/air/caa/caa_history.html).

pollution, issue notices of violations, and levy fines. It is appropriate for the states to take the lead because state and local agencies need to select and enforce pollution control strategies that make sense for their region. Geography, weather conditions, housing patterns, regional traffic patterns, and the nature of local industry all influence pollution levels.<sup>2</sup>

The Clean Air Act and its amendments specify deadlines for the U.S. EPA, states, local governments, and businesses to reduce air pollution. Each state is required to develop a plan that explains the actions it will take to meet or maintain the air quality standards set by the U.S. EPA. A *state implementation plan (SIP)* is a collection of the regulations a state will use. The U.S. EPA must approve each state's SIP. The U.S. EPA assists the states by providing scientific research, expert studies, engineering designs, and money to support clean-air programs.

## AIR QUALITY STANDARDS

Air pollutants are natural and artificial airborne substances that may be introduced into the environment in a sufficient concentration to have a measurable effect on humans, animals, vegetation, or building materials. From a regulatory standpoint, substances become air pollutants when the U.S. EPA determines them to be.

As part of the process, the Clean Air Act requires the U.S. EPA to issue a *criteria document* that provides details on the adverse effects of individual pollutants. Regulated pollutants therefore are referred to as *criteria pollutants*. The U.S. EPA uses the information in the criteria documents to set National Ambient Air Quality Standards (NAAQS) at levels that protect the public health and welfare. Table 2.1 lists criteria pollutants and their federal limits. California standards, which in most cases are more stringent, also are listed. Some of the criteria pollutants, such as carbon monoxide, are *primary pollutants*, which are emitted directly by identifiable sources. Others, such as ozone, are *secondary*

Table 2.1

U.S. Ambient Air Quality Standards

Criteria Pollutant	Averaging Time	Maximum Average Concentration	
		Federal Standard	California Standard
Ozone, ppm	1-hour	–	0.09
	8-hour	0.075	0.070
Carbon monoxide (CO), ppm	1-hour	35	20
	8-hour	9	9.0
Nitrogen dioxide (NO <sub>2</sub> ), ppm	1-hour	–	0.18
	Annual	0.053	0.030
Sulfur dioxide (SO <sub>2</sub> ), ppm	1-hour	–	0.25
	24-hour	0.14	0.04
	Annual	0.030	–
Suspended particulate matter (PM <sub>10</sub> ), µg/m <sup>3</sup>	24-hour	150	50
	Annual	–	20
Suspended particulate matter (PM <sub>2.5</sub> ), µg/m <sup>3</sup>	24-hour	35	–
	Annual	15	12
Lead, µg/m <sup>3</sup>	30-day	–	1.5
	Quarterly	1.5	–
Sulfates, µg/m <sup>3</sup>	24-hour	–	25
Hydrogen sulfide, ppm	1-hour	–	0.03
Vinyl chloride, ppm	24-hour	–	0.01

<sup>2</sup> *The Plain English Guide to the Clean Air Act*, EPA-456-07-001, April 2007. Available online at <http://www.epa.gov/air/caalpeg/>.

Table 2.2

**European Union Ambient Air Quality Standards  
(Directives 1999/30/EC, 2000/69/EC, 2002/3/EC, 2004/107/EC)**

Pollutant	Legal Nature*	Concentration, max	Averaging Period	Effective Date	Permitted Exceedences Each Years
Sulfur dioxide (SO <sub>2</sub> ), µg/m <sup>3</sup>	Limit	350	1-hour	Jan. 1, 2005	24
		125	24-hour	Jan. 1, 2005	3
		20	Annual and winter**	July 19, 2001	–
Nitrogen dioxide (NO <sub>2</sub> ), µg/m <sup>3</sup>	Limit	200	1-hour	Jan. 1, 2010	18
		40	Annual	Jan. 1, 2010	–
Nitrogen oxides (NO <sub>x</sub> ), µg/m <sup>3</sup>	Limit	30	Annual	July 19, 2001	–
Suspended particulate matter (PM <sub>10</sub> ), µg/m <sup>3</sup>	Limit	50	24-hour	Jan. 1, 2005	35
		40	Annual	Jan. 1, 2005	–
		50	24-hour	Jan. 1, 2010	7
		20	Annual	Jan. 1, 2010	–
Lead (Pb), µg/m <sup>3</sup>	Limit	0.5	Annual	Jan. 1, 2005	–
Carbon monoxide (CO), µg/m <sup>3</sup>	Limit	10	Maximum daily 8-hr mean	Jan. 1, 2005	–
Benzene, µg/m <sup>3</sup>	Limit	5	Annual	Jan. 1, 2010	–
Ozone, µg/m <sup>3</sup>	Target	120	Maximum daily 8-hr mean	Jan. 1, 2010	25 days averaged over 3 years
Arsenic (As), ng/m <sup>3</sup>	Target	6	Annual	Dec. 31, 2012	–
Cadmium (Cd), ng/m <sup>3</sup>	Target	5	Annual	Dec. 31, 2012	–
Nickel (Ni), µg/m <sup>3</sup>	Target	20	Annual	Dec. 31, 2012	–
PAH as Benzo(a)pyrene, ng/m <sup>3</sup>	Target	1	Annual	Dec. 31, 2012	–

\*Limit value is legally binding; target value is to be attained as far as possible by the attainment date and is less strict than a limit value.

\*\*Limit applies for calendar year as well as the Winter Period (Oct. 1 to March 31).

*pollutants*, which are formed by reactions in the atmosphere. Still others, such as particulates, are of mixed origin. Table 2.2 shows the ambient air quality standards for the European Union (EU).

## AIR POLLUTANTS

**Ozone (O<sub>3</sub>)** Ground-level ozone<sup>3</sup> is a colorless gas that is the chief component of urban smog. It is formed by the interaction of reactive organic gases, NO<sub>x</sub>, and sunlight. These reactions take time, which means that peak ozone concentrations can occur far downwind of reactant sources. Weather plays an important role; high temperatures, stagnant air, and sunny skies are optimum for creating ozone. This is why ozone concentrations tend to be highest in the summer months and are higher in the afternoon than at night.

Early in their regulatory histories and for decades thereafter, the U.S. EPA and the state of California used one-hour standards for ground-level ozone to identify nonattainment areas.

<sup>3</sup> In the stratosphere, a layer of ozone partially shields the earth from solar ultraviolet radiation. Stratospheric ozone is formed by a mechanism that is different from that which forms ground-level ozone.

(One-hour refers to the time frame in which ozone concentrations are averaged on a daily basis; the broader the time frame, the more likely an area is to exceed a standard's threshold.) In 1997, the U.S. EPA promulgated a new eight-hour standard believed to be more protective of human health. It also specified a threshold of 0.08 parts per million (ppm). Litigation delayed implementation of the new standard until April 2004. In 2008, the U.S. EPA revised its ground-level ozone standard to 0.075 ppm, extending the measurement to the third decimal place (see Table 2.1). While maintaining a one-hour standard, California adopted an additional eight-hour ground-level ozone standard in 2005.

Ozone levels have decreased 20 percent, on average, nationwide since 1980.<sup>4</sup>

Exposure to ozone has been linked to a number of health effects, including significant decreases in lung function, inflammation of the airways, and increased respiratory symptoms. Ozone also affects vegetation and ecosystems, leading to reductions in agricultural crop and commercial forest yields. In the U.S., ground-level ozone is responsible for an estimated \$500 million in reduced crop production each year.<sup>5</sup>

**Volatile Organic Compounds (VOCs)**<sup>6</sup> VOCs are not criteria pollutants, although some specific VOCs are classified as toxics (see later sections). The importance of VOCs stems from their role in forming ozone. Most hydrocarbon (HC) emissions are VOCs, which explains why so much effort is directed toward reducing HC emissions from vehicles and other source categories.

Global VOC emissions primarily come from vegetation (377 million metric tons carbon equivalent annually), fossil fuels (161 million metric tons carbon equivalent annually), and biomass burning (33 million metric tons carbon equivalent annually).<sup>7</sup> In the 20-year period from 1983 to 2002, anthropogenic VOC emissions in the U.S. decreased by 40 percent.<sup>8</sup> On-road gasoline vehicles accounted for about 26 percent of man-made VOC emissions in 2002 (Figure 2.2), the last year for which U.S. EPA data are available.

Not all hydrocarbons contribute equally to ozone formation. Some are more reactive than others, depending on their chemical structure and the atmospheric conditions to which they are subjected. Under most conditions, olefins and aromatics are more reactive than paraffins.

<sup>4</sup> "Air Trends, Ozone," U.S. EPA, <http://www.epa.gov/airtrends/ozone.html>.

<sup>5</sup> "Ozone – Good Up High Bad Nearby," U.S. EPA, <http://epa.gov/oar/oaqps/gooduphigh/>.

<sup>6</sup> VOC is the preferred term when discussing emissions. When the focus is on ozone formation, the term *reactive organic gases (ROGs)* is more common. The main difference is that VOC emissions include methane and ethane, which do not participate in ozone formation and thus are not ROGs. Another term sometimes used is *non-methane organic gases (NMOGs)*. For simplicity, this review will use the term VOC throughout.

<sup>7</sup> "Emissions of Greenhouse Gases in the United States 2003," Energy Information Administration, Department of Energy, <ftp://ftp.eia.doe.gov/pub/oiiaf/1605/cdrom/pdf/ggrpt/057303.pdf>.

<sup>8</sup> "National Air Quality and Emissions Trends Report, 2003 Special Studies Edition," Air Quality Trends Analysis Group, U.S. EPA, Research Triangle Park, N.C., September 2003. Available online at <http://www.epa.gov/airtrends/aqtrnd03/>.



Figure 2.2

**Emissions Sources:  
2002 National Man-Made VOC Emissions**  
16,544,000 short tons

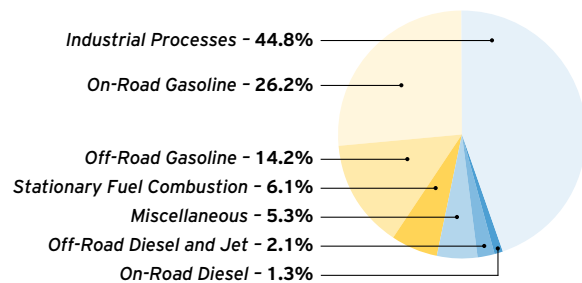

Figure 2.3

**Emissions Sources:  
2002 National Man-Made Carbon Monoxide Emissions**  
112,049,000 short tons

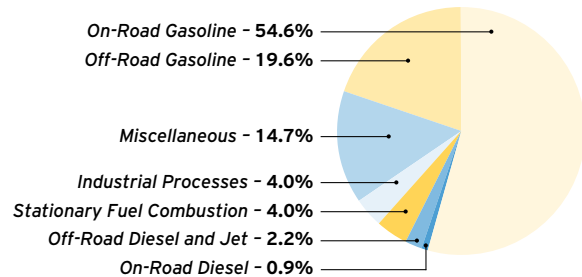
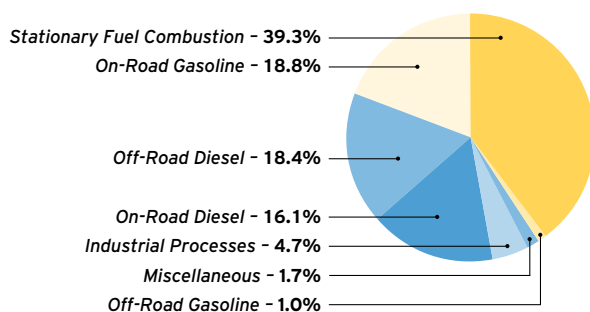

Figure 2.4

**Emissions Sources:  
2002 National Man-Made Nitrogen Oxide Emissions**  
21,102,000 short tons



Source: U.S. EPA, "Air Trends September 2003 Report: National Air Quality and Emissions Trends Report, 2003 Special Studies Edition."

**Carbon Monoxide (CO)** CO is a colorless, odorless gas generated primarily by combustion processes. It is toxic to humans and animals, and at high enough levels, CO causes headaches, nausea, and even death. CO toxicity stems from its ability to reduce the oxygen-carrying capacity of the blood by preferentially bonding to hemoglobin.

CO is formed when carbon in fuel is not burned completely. The highest ambient levels generally occur during the colder months, when atmospheric temperature inversions are more common, trapping CO emissions near the surface of the earth under a layer of warmer air. The U.S. EPA estimated that on-road gasoline vehicles were responsible for about 55 percent of man-made CO emissions nationwide in 2002 (Figure 2.3). In major cities, however, 85 percent to 95 percent of all CO emissions come from motor vehicle exhaust. Over the last decade, the auto industry has made remarkable advances in tightly controlling air-fuel ratio (A/F), which reduces CO emissions. This, combined with continuing refinements in catalyst technology that cleans up pollutants from engine exhaust, has helped to drastically reduce CO emissions from today's cars.

**Nitrogen Oxides (NO<sub>x</sub>)** NO<sub>x</sub> is the generic term for several reactive gases containing nitrogen and oxygen in various ratios. They form when fuel is burned at high temperatures. The U.S. air quality standard applies only to nitrogen dioxide (NO<sub>2</sub>), but where emissions are concerned, NO and NO<sub>2</sub> are usually analyzed simultaneously and expressed as NO<sub>x</sub>. This is because NO oxidizes in the atmosphere to form NO<sub>2</sub>, a more toxic compound. Most NO<sub>x</sub> emissions (90 percent) are man-made. The main sources are motor vehicles and industrial/commercial sources that burn fuels. The U.S. EPA estimated that on-road gasoline vehicles generated about 19 percent of man-made NO<sub>x</sub> emissions in 2002 (Figure 2.4).

NO is nontoxic by itself, but it contributes to ozone formation. The resulting atmospheric product, NO<sub>2</sub>, can irritate lungs and lower resistance to respiratory infection. In some western areas of the United States, NO<sub>x</sub> is an important precursor to particulate concentrations.<sup>9</sup>

**Sulfur Dioxide (SO<sub>2</sub>)** SO<sub>2</sub> is produced primarily from the combustion of fuels containing sulfur. Facilities that burn fuel oil and coal are the major sources. On-road and off-road engine fuels are estimated

<sup>9</sup> "National Air Quality and Emissions Trends Report, 2003 Special Studies Edition," Air Quality Trends Analysis Group, U.S. EPA, Research Triangle Park, N.C., September 2003. Available online at <http://www.epa.gov/airtrends/aqtrnd03/>.

to be the source of less than 3 percent of total SO<sub>2</sub> emissions, and this contribution further declined because of the implementation of the U.S. EPA's ultra-low sulfur diesel fuel regulations and similar sulfur limits in Europe and many other countries.

SO<sub>2</sub> is a moderate lung irritant. Both SO<sub>2</sub> and NO<sub>x</sub> are major precursors to acidic deposition (acid rain).

**Particulate Matter (PM<sub>10</sub> and PM<sub>2.5</sub>)** PM<sub>10</sub> is composed of airborne particles less than 10 microns (0.0004 inch) in diameter. (For comparison, the diameter of a human hair is 50 microns to 100 microns). The U.S. EPA estimates that fugitive dust from roads accounts for about two-thirds of total PM<sub>10</sub> emissions. Less than 2 percent is attributed to on-road and off-road engines, but the percentage is higher in urban areas. PM<sub>10</sub> attributable to vehicle exhaust includes both primary carbon particles (mainly from diesel) and secondary sulfate and nitrate aerosols formed by reactions of SO<sub>2</sub> and NO<sub>x</sub> in the atmosphere. Both the U.S. EPA and California have established PM<sub>10</sub> standards.

PM<sub>2.5</sub> is a subset of PM<sub>10</sub> composed of particles less than 2.5 microns in diameter. Such particles are small enough to reach deep in the lungs and may contain substances particularly harmful to human health. The U.S. EPA promulgated national 24-hour and annual PM<sub>2.5</sub> standards in 1997. In 1999, the U.S. EPA and its state, tribal, and local air pollution control partners deployed a monitoring network to measure PM<sub>2.5</sub> concentrations nationwide and have accumulated data for several years. The U.S. EPA used these data to identify geographic areas not attaining the standards and issued notices of nonattainment in 2005, which started the clock on establishment of SIPs for affected areas.

**Lead** Gasoline-fueled vehicles were the primary source of airborne lead when gasoline contained a lead alkyl antiknock additive, such as tetraethyl lead (TEL). In the U.S. between 1970 and 1994, the lead content in leaded gasoline was phased down, sales of unleaded gasoline increased, and total national lead emissions decreased sharply. The sale of gasoline containing lead additives was finally prohibited for on-road use in January 1996. On-road gasoline-fueled vehicles in the U.S. today are not responsible for atmospheric lead concentrations.

Excessive exposure to lead may cause neurological impairments such as seizures, mental retardation, and behavioral disorders. Fetuses, infants, and children are especially vulnerable even to low doses of lead. The hazardous threshold for blood lead poisoning is still being disputed.

**Toxic Organics** The toxicity of organic compounds depends on their structure. Most hydrocarbons are nontoxic at low concentrations, with benzene a notable exception. Some low-molecular-weight aldehydes are carcinogens, and some monocyclic and polycyclic aromatic hydrocarbons (PAH)<sup>10</sup> are suspected or known carcinogens.

<sup>10</sup> Also called polycyclic organic matter (POM); consists of polycyclic aromatic hydrocarbons (PAH), including benzo(a)pyrene, their nitrogen analogs, and a small number of oxygen-containing polycyclic organic matter compounds.

### **Fuel Economy and Emissions**

*Intuition suggests that one engine that burns more fuel than another over a given distance would produce more emissions, but that is not true. Vehicle emissions standards for new vehicles are set in terms of the mass of pollutant emitted per distance traveled. So, for example, a heavy, large-engine passenger vehicle may burn twice as much fuel as a lighter, small-engine vehicle over a given distance, but both vehicles must meet the same emissions standards and both will produce equivalent emissions per distance traveled. The large-engine vehicle in this example will, however, produce twice as much CO<sub>2</sub> as the small-engine vehicle. CO<sub>2</sub> is the result of complete oxidation of the carbon atoms in gasoline, and the amount of CO<sub>2</sub> produced is directly proportional to fuel economy. Pursuant to a Supreme Court ruling in 2009, the U.S. EPA issued a proposed finding that greenhouse gases, including CO<sub>2</sub>, contribute to air pollution that may endanger public health or welfare. The U.S. Congress and the U.S. EPA are pursuing legislation and regulation that will reduce greenhouse gases, including limits on fuels and vehicle economy. In Europe, the auto industry has a target of 140g CO<sub>2</sub>/km for the new-car fleet by 2008. Europe uses g CO<sub>2</sub>/km as a more appropriate fuel economy measure because the fleet includes both gasoline- and diesel-fueled passenger cars.*

The Clean Air Act Amendments of 1990 classified the following as toxic air pollutants related to gasoline and gasoline vehicles:

- Benzene
- Polycyclic organic matter (POM)
- Acetaldehyde
- Formaldehyde
- 1,3-Butadiene

The U.S. EPA calculates that these five toxic compounds comprise 3.8 percent of total VOC emissions. About 70 percent of that amount is benzene. 1,3-Butadiene, formaldehyde, and acetaldehyde are not present in gasoline; they are formed during combustion.

Benzene is a known human carcinogen. Some POMs are also carcinogens, but the POM content of gasoline and gasoline exhaust is so low as to be difficult to measure. The two aldehydes are eye and throat irritants, and formaldehyde is a suspected human carcinogen.

### **ORIGIN OF VEHICLE EMISSIONS<sup>11</sup>**

When fuel is burned with the correct amount of air in a gasoline-powered engine, the gases that are left are predominantly water vapor, carbon dioxide, and nitrogen. All of these gases are benign, although carbon dioxide is a greenhouse gas. Deviations from ideal combustion lead to the production of some VOCs, CO, NO<sub>x</sub>, and PM<sub>10</sub>.<sup>12</sup>

As noted earlier, gasoline-powered vehicles tend to be the main source of CO emissions, and they contribute substantially to urban VOC and NO<sub>x</sub> emissions. However, significant improvement in emission controls on new cars has diminished their contribution of these pollutants. New cars emit only modest amounts of PM<sub>10</sub> and PM<sub>2.5</sub>, but vehicles that are ill-maintained or tampered with can emit much more. Older diesel-powered vehicles without particulate traps, on the other hand, are substantial emitters of PM<sub>10</sub>, PM<sub>2.5</sub>, and NO<sub>x</sub> but only small emitters of CO and VOCs. (See figures 2.2, 2.3, and 2.4.)

**Exhaust VOC** The vast majority of gasoline is burned before combustion gases exit the engine in a properly operating vehicle, but a small fraction, typically 1 percent to 5 percent, escapes the combustion chamber unburned. These VOC emissions consist primarily of unburned hydrocarbons, but partially burned oxygen-containing compounds such as aldehydes are also present in small amounts. Most are removed by a vehicle's catalytic converter. The quantity of exhaust VOC emissions is influenced by many factors, including engine design, controls, and condition; operating temperature; A/F; fuel system deposits; and catalytic converter performance. If a vehicle has a malfunctioning component that inhibits proper ignition or combustion, such as a bad spark plug, VOC emissions can be many times higher than normal.

<sup>11</sup> A significant amount of emissions-related information may be obtained from the U.S. EPA Office of Transportation and Air Quality site at <http://www.epa.gov/otaq/index.htm>.

<sup>12</sup> For details on pollutant formation and control in gasoline engines, see John B. Heywood, *Internal Combustion Engine Fundamentals*, McGraw-Hill, New York, 1988.

**Evaporative VOC** Exhaust gases are not the only source of VOC emissions from gasoline-fueled vehicles. In fact, the U.S. EPA estimated that in 1990 more than half the VOCs emitted from gasoline vehicles came from evaporation. Evaporative VOC emissions differ from exhaust VOC emissions in that evaporative emissions contain no combustion products. Because evaporative VOC emissions originate largely from gasoline vapor, their composition is weighted heavily toward the lowest boiling components of gasoline.

Gasoline vapor escapes from a typical vehicle at various points, including the fuel tank, carburetor (on vehicles that use them), and intake manifold. In addition, liquid gasoline can permeate plastic fuel tanks and elastomeric fuel hoses, and the permeation effects are greater with ethanol-blended gasoline. Liquid gasoline can also leak or seep from fuel system components or connections.<sup>13</sup> Factors that influence the amount of evaporative emissions include:

- Fuel system design (see page 65)
- Gasoline vapor pressure (see page 2)
- Component integrity
- Gasoline composition
- Ambient temperature

Of course, a certain amount of gasoline vapor is lost during fueling, though most of it may be collected by service station vapor recovery systems, where installed.

**Carbon Monoxide** CO is the result of incomplete combustion of fuel, and the main factor influencing its production is the ratio of air to fuel in an engine combustion chamber. If the mixture of air and gasoline is fuel-rich, that is, has insufficient air ( $O_2$ ) to convert all fuel carbon to carbon dioxide ( $CO_2$ ), the exhaust will contain a high level of CO. Fuel-rich operation can result either by design or by accident.

Prior to the introduction of vehicle emissions standards, most gasoline vehicles ran slightly fuel-rich most of the time and produced a lot of CO. Later, manufacturers designed vehicles to minimize fuel enrichment but also to allow for short periods of enrichment to aid vehicle starting and to increase power output under certain conditions. Today's cleanest vehicles use minimal or no cold-start enrichment. Power enrichment is being greatly reduced since the U.S. EPA bolstered its vehicle certification requirements with the Supplemental Federal Test Procedure (SFTP), which tests for emissions at high-speed and under high-power conditions.

Irrespective of its design, a vehicle may operate fuel-rich when its fuel supply or control system accidentally malfunctions. The causes are many but include:

- Deterioration or failure of components such as the carburetor or oxygen sensor.
- Deposits formed over time in fuel injectors or carburetors by poor-quality gasoline.
- Maintenance deficiencies such as maladjustment or neglect.

<sup>13</sup> In these cases, the composition of the evaporative VOCs will be characteristic of the whole gasoline.

**Oxides of Nitrogen** NO<sub>x</sub> is produced differently than CO and exhaust VOCs. The latter are products of incomplete combustion; NO<sub>x</sub> is produced when combustion is robust. It is generated by reactions of nitrogen and oxygen, which occur at high temperatures. Nitrogen is always present in a combustion chamber because air is roughly 80 percent nitrogen. The production of NO<sub>x</sub> occurs whenever residual oxygen is present during combustion and is particularly prevalent with higher combustion temperatures. Thus, NO<sub>x</sub> is affected by the A/F and by engine design factors that influence temperature, such as compression ratio, spark timing, and cooling system performance. Combustion chamber deposits are believed to have a modest insulating effect that raises combustion temperatures and increases NO<sub>x</sub> emissions slightly.

## VEHICLE EMISSIONS: LIMITS

The Clean Air Act required the U.S. EPA to set standards or limits for exhaust emissions from gasoline-powered cars starting with the 1968 model year. These first limits applied

Table 2.3

U.S. Federal Passenger Car Exhaust Emission Standards

Model Year	Useful Life, Years/1M Miles	Maximum Emissions g/mile (FTP-75 Cycle)			
		Carbon Monoxide (CO)	Hydrocarbons (HC)	Oxides of Nitrogen (NO <sub>x</sub> )	Particulates (PM <sub>10</sub> )
Pre-control (estimated)	–	84	10.6	4.1	–
1968-69	5/50	51	6.3	–	–
1970-71	5/50	34	4.1	–	–
1972	5/50	28	3.0	–	–
1973-74	5/50	28	3.0	3.1	–
1975-76	5/50	15	1.5	3.1	–
1977-79	5/50	15	1.5	2.0	–
1980	5/50	7.0	0.41	2.0	–
1981-90	5/50	3.4 <sup>1</sup>	0.41	1.0	–
1991-93	5/50	3.4	0.41	1.0	0.20
1994-98 Tier 1 <sup>2</sup>	5/50	3.4	0.25 <sup>3</sup>	0.4	0.08
	10/100	4.2	0.31 <sup>3</sup>	0.6	0.10
1999-2003 NLEV <sup>4</sup>	5/50	3.4	0.075 <sup>5</sup>	0.2	0.08
	10/100	4.2	0.090 <sup>5</sup>	0.3	0.08
2004-2007	5/50	3.4	0.75-0.100 <sup>5</sup>	0.05-0.14	–
Tier 2 <sup>6</sup> Bins (1-8)	10/120	0.0-4.2	0.000-0.125 <sup>5</sup>	0.00-0.20	0.00-0.02

<sup>1</sup> 1981-82 model years allowed 7.0 g/mile with waiver.

<sup>2</sup> Standards phased in progressively between 1994 and 1997.

<sup>3</sup> Non-methane hydrocarbon (NMHC).

<sup>4</sup> Optional program.

<sup>5</sup> Non-methane organic gas (NMOG).

<sup>6</sup> Tier 2 regulation defines 8 "bins" into which vehicles can be certified to varying standards so long as the manufacturer meets an average NO<sub>x</sub> standard of 0.07 g/mile when standards are fully implemented in 2007. Standards phased in progressively between 2004 and 2007.

to CO and hydrocarbons, with limits for NO<sub>x</sub> added starting in the 1973 model year. Table 2.3 shows how U.S. limits for passenger cars, expressed as grams per mile (g/mile), have been tightened over the years. Beginning in 1994, vehicles were certified for longer life spans and the emissions limits for the first five years/50,000 miles became more stringent, as shown in Table 2.3. Beginning in 2004 with full implementation in 2007 for light-duty vehicles, the new federal Tier 2 120,000-mile tailpipe standards established eight permanent and three temporary "certification bins" with an average standard of 0.07 g/per mile for NO<sub>x</sub> for all classes of passenger vehicles, sport utility vehicles, and light-duty trucks.

California has a separate set of passenger car limits that were applied initially to 1966 model year passenger cars. Typically, California limits have preceded federal limits by a couple of years. Different federal and California



limits apply for light-duty trucks, heavy-duty trucks, and buses. Chapter 5, “Gasoline Engines and Selected Systems,” describes the variety of emission control devices and strategies employed to reduce emissions from gasoline-powered vehicles.

Table 2.4 shows current and future EU vehicle emissions standards. Japan’s vehicle emissions standards for passenger cars and light-duty trucks are presented in Table 2.5. Straight comparisons of U.S., EU, and Japanese standards are not possible because the specified test cycles differ.

Because exhaust emissions are very dependent on how a vehicle is operated, a standard set of test conditions is needed to certify that new vehicles meet their prescribed emission

Table 2.4

**European Union Emission Standards<sup>1</sup> Passenger Cars and Light Commercial Vehicles – Gasoline Engines**

Directive	Tier	Useful Life Years/1M Miles	Effective Date for New Type Approvals	Vehicle Type <sup>2</sup> (Category)	Maximum Emissions, g/km (ECE 15 + EUDC / NEDC) <sup>3,4</sup>					
					CO	HC	NMHC <sup>5</sup>	HC + NO <sub>x</sub>	NO <sub>x</sub>	Particulates (PM <sub>10</sub> ) <sup>6</sup>
91/441/EEC	Euro 1	–/80 <sup>7</sup>	July 1992	PC (M)	2.72 (3.16)	–	–	0.97 (1.13)	–	–
93/59/EEC	(EC 93)	–/–	Oct. 1994	LCV (N Class I)	2.72 (3.16)	–	–	0.97 (1.13)	–	–
				LCV (N Class II)	5.17 (6.0)	–	–	1.40 (1.6)	–	–
				LCV (N Class III)	6.9 (8.0)	–	–	1.7 (2.0)	–	–
94/12/EC	Euro 2	–/80 <sup>7</sup>	Jan. 1996	PC (M)	2.2	–	–	0.5	–	–
96/69/EC	(EC 96)	–/–	Jan. 1998	LCV (N Class I)	2.2	–	–	0.5	–	–
				LCV (N Class II)	4.0	–	–	0.6	–	–
				LCV (N Class III)	5.0	–	–	0.7	–	–
98/69/EC	Euro 3	5/80	Jan. 2000	PC (M)	2.3	0.20	–	–	0.15	–
2002/80/EC				LCV (N Class I)	2.3	0.20	–	–	0.15	–
			Jan. 2001	LCV (N Class II)	4.17	0.25	–	–	0.18	–
				LCV (N Class III)	5.22	0.29	–	–	0.21	–
	Euro 4	5/100	Jan. 2005	PC (M)	1.0	0.10	–	–	0.08	–
				LCV (N Class I)	1.0	0.10	–	–	0.08	–
			Jan. 2006	LCV (N Class II)	1.81	0.13	–	–	0.10	–
				LCV (N Class III)	2.27	0.16	–	–	0.11	–
Proposed	Euro 5	5/160	Sept. 2009 <sup>9</sup>	PC (M)	1.000	0.100	0.068	–	0.060	0.0050
	Euro 6 <sup>8</sup>		Sept. 2010	LCV (N Class I)	1.000	0.100	0.068	–	0.060	0.0050
				LCV (N Class II)	1.810	0.130	0.090	–	0.075	0.0050
				LCV (N Class III)	2.270	0.160	0.108	–	0.082	0.0050

<sup>1</sup> Straight comparison with the U.S. standards is impossible since the test cycles are different.

<sup>2</sup> PC = Passenger Car; LCV = Light Commercial Vehicle; categories and classes defined by Directives 70/156/EEC and 2001/116/EEC.

<sup>3</sup> New European Driving Cycle (NEDC) became effective with Euro 3.

<sup>4</sup> Values in parentheses are limits on conformity of production (COP).

<sup>5</sup> NMHC = Non-methane hydrocarbons.

<sup>6</sup> Applicable only to vehicles with direct-injection engine.

<sup>7</sup> Durability requirement for vehicles equipped with emission control devices.

<sup>8</sup> Basic standards for Euro 5 and 6 are the same for gasoline-powered PC and LCV; however, standards for diesel-powered vehicles differ for the two tiers.

<sup>9</sup> Effective date is September 2010 for PC > 2,500 kg.

Table 2.5

Japanese Vehicle Emission Specifications<sup>1</sup> – Gasoline Engines

Implementation Year	Vehicle Type <sup>2</sup>	Test Method	Units	Mean Limits <sup>3</sup>				
				CO	HC	NMHC <sup>4</sup>	NO <sub>x</sub>	PM <sup>5</sup>
2000	Passenger Car	10.15 Mode	g/km	0.67	0.08	–	0.08	–
		11 Mode	g/test	19.0	2.20	–	1.40	–
	LD Truck/Bus	10.15 Mode	g/km	0.67	0.08	–	0.08	–
		11 Mode	g/test	19.0	2.20	–	1.40	–
2001	MD Truck/Bus	10.15 Mode	g/km	2.10	0.08	–	0.13	–
		11 Mode	g/test	24.0	2.20	–	1.60	–
2002	Mini Truck/Bus	10.15 Mode	g/km	3.30	0.13	–	0.13	–
		13 Mode	g/test	38.0	3.50	–	2.20	–
2005	Passenger Car	10.15 Mode + 11 Mode	g/km	1.15	–	0.05	0.05	–
	LD Truck/Bus	10.15 Mode + 11 Mode	g/km	1.15	–	0.05	0.05	–
	MD Truck/Bus	10.15 Mode + 11 Mode	g/km	2.55	–	0.05	0.07	–
2007	Mini Truck/Bus	10.15 Mode + 11 Mode	g/km	4.02	–	0.05	0.05	–
2009	Passenger Car	10.15 Mode + JC08 Mode	g/km	0.63	–	0.24	0.05	0.005
	LD Truck/Bus	10.15 Mode + JC08 Mode	g/km	0.63	–	0.24	0.05	0.005
	MD Truck/Bus	10.15 Mode + JC08 Mode	g/km	0.63	–	0.24	0.07	0.007

<sup>1</sup> Straight comparison with the U.S. standards is impossible since the test cycles are different.

<sup>2</sup> LD = Light-Duty, GVW <1,700 kg; MD = Medium-Duty, GVW >1,700 kg and <3,500 kg.

<sup>3</sup> Type approval and production mean limit; for production >2,000 units per annum.

<sup>4</sup> NMHC = Non-methane hydrocarbon.

<sup>5</sup> Limits on particulate matter (PM) apply only to direct-injection, lean-burn vehicles equipped with adsorption-type NO<sub>x</sub> reduction catalysts.

limits. The U.S. EPA requires measuring exhaust emissions while a vehicle is driven according to a specified speed-time cycle on a dynamometer. The cycle used currently is Federal Test Procedure 75 (FTP 75), which simulates a 7.5-mile urban driving route with a cold start, frequent stops, and an average speed of 19.6 mph. With the Tier 2 emission standards, the U.S. EPA phased in the SFTP (mentioned earlier). This test cycle has a higher average speed and incorporates some robust vehicle accelerations to ensure that new vehicles have acceptably low exhaust emissions under such conditions.

## INSPECTION AND MAINTENANCE

In addition to establishing emission limits for new vehicles, the U.S. EPA has long recognized the importance of making sure that vehicles in use continue to function as they were designed. The emission control systems of a modern gasoline-powered vehicle are complex (see Chapter 5, “Gasoline Engines and Selected Systems”). To deliver the intended emissions performance, all of the systems must function properly. A single defect can compromise the effectiveness of several subsystems and greatly increase emissions. For example, a fault that causes an engine to operate fuel-rich will not only increase production of CO and HC in the engine but will drastically reduce the ability

of the catalyst to eliminate these pollutants, thus increasing their emission by a factor of perhaps 10 or more. When this happens, one “broken” vehicle can pollute as much as 10 properly functioning vehicles can. Thus, regular inspection of an engine and its emission controls, plus prompt and effective repair of any defects, can be as important to clean air as requiring the controls initially.

In 1983, the U.S. EPA oversaw the introduction of Inspection and Maintenance (I/M) programs in a number of states with air quality problems. These mandatory programs, often referred to as *smog inspections*, require a vehicle to undergo a set of inspections to detect if its emission control systems are defective or have been tampered with. The inspections may be conducted at state-run facilities or at privately owned shops. Most involve visually checking a vehicle for obviously broken, damaged, or missing emission control components and measuring tailpipe emissions. If a vehicle fails any of the tests, its owner usually is required to have the affected items repaired, subject to certain cost limits. The 1990 Clean Air Act Amendments require a number of regions in the U.S. to implement more stringent I/M programs.<sup>14</sup>

Today’s new vehicles have mandatory systems called *on-board diagnostics (OBD)* that can identify many of the problems that lead to significant increases in emissions (for example, problems with the catalytic converter or with the exhaust oxygen sensor that is part of the closed-loop A/F control system). Eventually, OBD may obviate the need for I/M programs.

## VEHICLE EMISSIONS: GASOLINE EFFECTS

Changes in gasoline properties and composition can help reduce vehicle emissions. Certain gasoline modifications are very effective at enabling vehicle emission control systems to perform at their optimum levels. Other gasoline modifications are not nearly as effective at reducing emissions compared to the use of the vehicle emission control systems described in Chapter 5, “Gasoline Engines and Selected Systems.” The explanations here apply chiefly to vehicles built since 1985.

**Sulfur** Sulfur in fuel becomes sulfur oxides in exhaust that temporarily poison the three-way catalyst. Reducing gasoline’s sulfur content increases converter efficiency and decreases VOC, CO, NO<sub>x</sub>, and toxics emissions. Sulfur also interferes with OBD catalyst monitoring sensor performance in lean-burn engines.

Although gasoline engines are not a major source of SO<sub>2</sub>, a criteria pollutant, reducing gasoline sulfur content also reduces the direct emission of this pollutant.

**Vapor Pressure** Decreasing the vapor pressure of gasoline reduces evaporative VOC emissions and, to a lesser extent, can reduce exhaust VOC and CO.

<sup>14</sup> Detailed information regarding I/M programs can be obtained from the U.S. EPA National Vehicle and Fuel Emission Laboratory, 2000 Traverwood Drive, Ann Arbor, Michigan 48105. Regulations regarding I/M programs can be found in the U.S. Code of Federal Regulations, Volume 40, Part 51 (40 CFR 51), Subpart S.

---

**Oxygenates** As explained earlier, CO is a result of incomplete combustion, and its formation is very dependent on A/F. In older cars, adding oxygenates to gasoline has the same effect as increasing the amount of combustion air. Oxygenated gasolines add more oxygen to a combustion chamber, make combustion more complete, and help reduce formation of carbon monoxide.

Oxygenates also tend to reduce exhaust VOC emissions somewhat, but they increase aldehyde emissions and tend to increase NO<sub>x</sub> emissions in many vehicles. As explained previously, NO<sub>x</sub> formation is increased by excess oxygen and higher combustion temperatures. This relationship between oxygen and increased NO<sub>x</sub> caused California and, until recently, the U.S. EPA to limit the oxygen content of reformulated gasolines. The emissions benefit of oxygenates was greatest in pre-1990 vehicles with less effective A/F control systems than the closed-loop A/F control systems in newer vehicles. By adjusting intake A/F based on the oxygen content of exhaust, the newer systems compensate for oxygen in fuel, negating most of the emissions benefit associated with using oxygenated gasoline. The addition of adaptive learning systems has improved A/F control even more. Consequently, oxygenates seem to have little effect on exhaust emissions from newer vehicles, so long as the vehicles are operating in closed-loop mode.

Because of recent advances in automotive technology, the U.S. EPA has acknowledged that the oxygen component of RFG is not required to achieve the air quality benefits that were targeted by the Clean Air Act Amendments of 1990. With the Energy Policy Act of 2005, the U.S. Congress directed the U.S. EPA to rescind the requirement that federal RFG must contain oxygenated components. This was implemented in 2006. Although the U.S. EPA no longer requires the use of oxygenates in these gasolines, almost all gasolines used in federal RFG areas and in California are blended with ethanol and are therefore still oxygenated gasolines.

**Olefins** Increasing the olefin content of gasoline tends to reduce exhaust VOC emissions because olefins burn more easily and more completely than the other classes of hydrocarbons in gasoline. However, increasing olefin content also tends to increase NO<sub>x</sub> formation. It also increases the olefin content of evaporative emissions, which is undesirable because olefins are among the most reactive hydrocarbons for ozone formation. For reformulated gasolines, the choice is to decrease olefins.

**Aromatics** Decreasing the total aromatics content of gasoline may reduce CO and exhaust VOC emissions, but the effects are variable and complex, probably because the aromatic compounds in gasoline are so diverse. Decreasing aromatics content reduces benzene in vehicle exhaust emissions because larger aromatic molecules are partly converted to benzene during combustion or in the catalytic converter.

**Benzene** Decreasing the benzene content of gasoline reduces the amount of benzene in both evaporative and exhaust VOC emissions.

**Distillation Profile Temperatures** Gasoline containing significant amounts of high-temperature boiling components tends to generate high VOC exhaust emissions. High-temperature boiling components are more difficult to vaporize, especially in a cold engine, making complete combustion more difficult. Thus, placing limits on the distillation profile of gasoline can help lower VOC emissions.

## REFORMULATED GASOLINES

Acting on the above relationships, the U.S. EPA and CARB have established a number of regulations that control gasoline properties to reduce emissions from gasoline-fueled vehicles. The chronology is shown in Figure 2.5.

In 1992, for example, the U.S. EPA required a decrease in the maximum vapor pressure of summertime gasoline to reduce evaporative VOC emissions. It capped vapor pressure at 54 kPa (7.8 psi) in ozone nonattainment areas in the Southern and Western states, where average summer temperatures are highest, and at 62 kPa (9.0 psi) elsewhere across the nation.

That same year, California Phase 1 RFG was required throughout California. Phase 1 RFG regulations capped summertime vapor pressure at 54 kPa (7.8 psi) for the entire state, not just for ozone nonattainment areas, and forbade the use of lead-containing additives. The regulations also made the use of deposit control additives mandatory on the basis that engine intake system deposits increase emissions (see page 77). The U.S. EPA mandated that all U.S. motor gasoline contain a deposit control additive beginning in 1995.

Figure 2.5

Chronology of United States Gasoline Regulations

Federal	California
	1960 <b>Bromine Number</b> Control/reduce the formation of ozone
	1971 <b>Summer Vapor Pressure</b> Reduce evaporative hydrocarbon emissions from vehicles and fuel distribution system and reduce ozone
	1976 <b>Sulfur Content</b>
	1978 Reduce sulfur oxide emissions
	1980 and particulates
<b>Unleaded Gasoline</b> 1974 Reduce health risks from airborne lead oxides and enable use of catalytic converters on vehicles to reduce emissions	
<b>Summer Vapor Pressure</b> 1989 Reduce evaporative hydrocarbon emissions from vehicles and fuel distribution system and reduce ozone	
<b>Summer Vapor Pressure</b> 1992 Further reduce evaporative hydrocarbon emissions and ozone	1992 <b>Phase 1 Reformulated (Summer Vapor Pressure)</b> Further reduce evaporative hydrocarbon emissions and ozone - more restrictive than federal requirements
<b>Winter Oxygen</b> Reduce carbon monoxide emissions from vehicles in nonattainment areas	<b>Winter Oxygen</b> Reduce carbon monoxide emissions from vehicles
	<b>Leaded Fuel Banned</b> Help protect public health
	<b>Deposit Control Additives</b> Reduce carbon monoxide emissions
<b>Phase I Reformulated</b> 1995 Reduce ozone and toxics in nonattainment areas	
<b>Deposit Control Additives</b> Reduce vehicle emissions caused by fuel system deposits	
<b>Leaded Fuels Banned</b> 1996 Help protect public health	1996 <b>Phase 2 Reformulated</b> Achieve maximum "cost-effective" reductions in vehicle emissions, including toxics
<b>Phase II Reformulated</b> 2000 Further reduce ozone and toxics in nonattainment areas	
<b>Tier 2 Sulfur Regulation</b> 2004 Increases effectiveness of advanced emission control technologies	2004 <b>Phase 3 Reformulated</b> Bans MTBE and provides more refinery blending flexibility
<b>Removal of Oxygenate Requirement for RFG</b> 2006 No longer required to achieve benefits in newer cars	
<b>Renewable Fuels Standard</b> Reduce dependence on imported oil	
<b>Benzene Regulation</b> 2011 Further reduce toxics	2010 <b>Phase 3 Reformulated Update</b> Compensate for effects of ethanol-blended gasoline on hydrocarbon and nitrogen oxide emissions
	2012



---

The year 1992 also saw implementation of the U.S. EPA's winter oxygenate program, which required the addition of oxygenates to gasoline sold in the 39 areas of the country that had not attained the NAAQS for CO. Gasoline in these areas was required to contain a minimum of 2.7 mass percent oxygen during the winter months when CO emissions tend to be highest. The four or five applicable winter months varied from area to area. Most of the original 39 areas have now attained the NAAQS for CO. However, eight areas in the Western U.S. continue to participate in the winter oxygenate program.<sup>15</sup>

In 1995, the U.S. EPA introduced regulations for Federal Phase I RFG to be used in the nine extreme or severe ozone nonattainment areas across the country.<sup>16</sup> Less severe ozone nonattainment areas were allowed to opt into the RFG program.

The U.S. EPA fixed two characteristics of Federal Phase I RFG. The average benzene content had to be less than 1 volume percent and the average year-round oxygen content had to be greater than 2.1 mass percent. Summertime vapor pressure also was limited. Otherwise, the general approach was to set vehicle emission reduction targets rather than place property or composition limits on gasoline. To make this work, the U.S. EPA provided refiners with a Simple Model, which expired in 1998, and a Complex Model, a more detailed mathematical model that relates gasoline composition to vehicle emissions. Criteria entered into the Complex Model are essentially those gasoline properties listed in the previous section. The model results are predicted levels of VOC, NO<sub>x</sub>, and toxics emissions from a standard in-use vehicle fleet. The Complex Model helps refiners meet the prescribed vehicle emissions reductions in the most cost-effective way for each particular refinery.

In mid-1996, CARB introduced its Phase 2 RFG regulation. In its initial form, the regulation created a recipe for gasoline by specifying eight parameters of gasoline volatility and composition. It placed limits on summertime vapor pressure, benzene, total aromatics, olefins and sulfur content as well as the temperatures for the 50 percent and 90 percent evaporated points from the distillation profile. It also required a minimum oxygen content year-round.

CARB subsequently modified the Phase 2 RFG regulation, allowing refiners to certify alternative compositions through the California Predictive Model. This model is similar to the U.S. EPA's Complex Model in concept but different in some particulars. CARB's intent was to reduce the cost of producing Phase 2 RFG by allowing refiners to show that an alternative gasoline (presumably less expensive to produce) would reduce vehicle emissions at least as much as the original Phase 2 recipe. Even when the Predictive Model is used, however, the eight parameters still place limits on gasoline volatility and composition. Some of these limits are less stringent than the equivalent limits in the original recipe but are still quite restrictive.

<sup>15</sup> "State Winter Oxygenated Fuel Program Requirements for Attainment or Maintenance of CO NAAQS," U.S. EPA, January 2008. Available online at <http://www.epa.gov/otaq/regs/fuels/420b08006.pdf>.

<sup>16</sup> The number of areas increased to 10 in 1996 with the addition of Sacramento, California, and then to 11 in 2002 with the addition of the San Joaquin Valley in California.

CARB believes that Phase 2 RFG, when first introduced, reduced vehicle VOC emissions by 17 percent, CO and NO<sub>x</sub> emissions by 11 percent, and air toxics by 44 percent, relative to California Phase 1 RFG. This was equivalent to removing approximately 3.5 million cars from California's roads.

The U.S. EPA introduced Phase II of its RFG program in 2000. The Phase II regulation continues Phase I's use of the Complex Model and retains the limits for benzene and oxygen content. However, it requires larger reductions in VOCs, toxics, and NO<sub>x</sub>. (Table 2.6 summarizes the emissions reductions that must be achieved for gasolines formulated under Phase I and Phase II.) Most refiners have decreased vapor pressure, benzene content, and sulfur content as their primary strategies to meet the Phase I and Phase II emissions limits.

California Phase 2 gasoline and Federal Phase II gasoline give roughly comparable reductions in VOCs and air toxics. With its lower sulfur content, the California fuel is believed to reduce NO<sub>x</sub> emissions by about 11 percent compared to 4 percent for the federal fuel.

California entered Phase 3 of its RFG program beginning January 1, 2004 (the regulation became effective December 31, 2003), although several refiners began producing Phase 3 RFG earlier than that. Phase 3 RFG regulations prohibit the intentional blending of methyl tertiary butyl ether (MTBE) into California gasoline. The presence of MTBE and other oxygenates has been disallowed, except for ethanol, above a *de minimis* level. California took this step because MTBE had been found in various fresh-water resources throughout the state and because it was viewed that certain amounts of MTBE could potentially affect the taste and odor of drinking water. Ethanol is now the only oxygenate that refiners can use for gasoline blending in California.

In addition to prohibiting MTBE, Phase 3 set lower limits for sulfur and benzene. Maximum average sulfur content was reduced from 30 ppm to 20 ppm, and the maximum level of benzene was reduced to 0.8 volume percent. Most other requirements for the new fuel were similar to those stipulated in Phase 2.

In 2004, the U.S. EPA began implementing Tier 2 gasoline sulfur regulations, which established new maximum standards for sulfur content in gasoline in all states except California. (California gasoline was exempted because the Phase 3 California RFG standards were already consistent with the new EPA standard.) The U.S. EPA Tier 2 gasoline sulfur regulations were phased in from 2004 to 2007. The new standard required the annual average sulfur content of gasoline produced by a refinery to be no more than 30 ppm by weight, with a cap of 80 ppm by weight on any individual batch of gasoline. By the end of 2009, gasoline nationwide must meet the 30 ppm average/80 ppm cap standards (although some small refiners are exempt until the end of 2010).

Table 2.6

**Reductions in Vehicle Emissions for Federal Phase I and Phase II Reformulated Gasoline Programs**

	Effective Date	Reduction in Emissions, % (Averaged Standard, Compared to 1990 Baseline Refinery Gasoline)		
		VOC	Toxics	NO <sub>x</sub>
<b>Phase I</b>				
Simple Model	1995	Vapor pressure limits	≥16.5	No increase
Complex Model	1998 <sup>1</sup>	≥17.1 <sup>2</sup> ≥36.6 <sup>3</sup>	≥16.5	≥1.5
<b>Phase II</b>				
Complex Model	2000	≥27.4 <sup>2</sup> ≥29.0 <sup>3</sup>	≥21.5	≥6.8

<sup>1</sup> Optional 1995-1997; mandatory starting in 1998.  
<sup>2</sup> Northern states.  
<sup>3</sup> Southern states.

---

In 2007, the U.S. EPA promulgated new regulations for benzene content in gasoline as part of the Control of Hazardous Air Pollutants from Mobile Sources regulation. This regulation established an annual average maximum benzene content in gasoline of 0.62 liquid volume percent, and it becomes effective January 1, 2011. Its objective is to further reduce the toxics content of gasoline exhaust.

Also in 2007, the U.S. EPA finalized regulations for the Renewable Fuel Standard (RFS), which was authorized by the Energy Policy Act of 2005. The RFS establishes a minimum requirement for the volume of renewable fuels blended into gasoline and diesel fuel. The national minimum volume requirement started at 4.0 billion gallons per year of renewable fuel in 2006 and increases to 7.5 billion gallons per year in 2012. Each producer and importer of gasoline in the U.S. is obligated to demonstrate compliance with this requirement based on the pro rata share of gasoline it produces or imports. With the passage of the Energy Independence and Security Act of 2007, the amount of renewable fuels required was increased to 15.2 billion gallons per year in 2012 and ends with a requirement of 36.0 billion per year by 2022. The proportional requirement for cellulosic biofuel in the act begins in 2010 and scales up to 16.0 billion gallons per year by 2022.

In 2007, CARB updated its Phase 3 RFG gasoline standards to address issues related to increased hydrocarbon emissions that resulted when the state switched from MTBE-blended gasoline to ethanol-blended gasoline in 2003. The increased hydrocarbon emissions result from ethanol-enhanced permeation of seals, hoses, and gaskets in vehicle fuel systems. Based on additional vehicle testing data, the California Phase 3 RFG Predictive Model was revised to account for the increased permeation emissions, requiring refiners to reduce the volatility of their base gasoline. In addition, the maximum sulfur content standard was also reduced to further control NO<sub>x</sub> emissions and prevent any backsliding on NO<sub>x</sub> that might be associated with blending ethanol at higher concentrations in the future. The revised Phase 3 RFG gasoline standards will phase in beginning in 2010, with full implementation by 2012.

On January 18, 2007, the governor of California issued an executive order establishing a Low Carbon Fuels Standard (LCFS) for transportation fuels sold in California. The implementation details are under development.

### European Union

In 2005, the EU initiated sulfur-content reductions in a move toward a 10 ppm maximum for all gasolines by 2009. The EU also limits aromatics to a maximum content of 35.0 volume percent. In addition to enforcing gasoline content limits, the EU helps states manage fuel availability through guidance on number and distance between refueling stations. These EU mandates are based on European Committee for Standardization specification CEN EN 228.

### Japan

In 2007, Japanese Industrial Standard (JIS) K 2202 for motor gasoline limited sulfur content to 10 ppm maximum and summertime vapor pressure to 9.4 psi (65 kPa) maximum.

# 3 • Gasoline Refining and Testing

Technology exists to make gasoline from coal, shale oil, oil sands, and exotic sources such as recycled plastics and rubber tires. These processes are complicated and expensive. Petroleum crude, also called *crude oil* or *crude*, continues to be the most economical source of gasoline.

The first step of gasoline refining is to isolate the gasoline naturally present in crude, much as the first refiners did. Then, in more complex steps, non-gasoline components of crude are converted into gasoline and gasoline molecules are rearranged to improve their characteristics. Understanding the various conversion steps requires knowing something about the hydrocarbon (HC) building blocks that make up gasoline and crude. This chapter first discusses the composition of gasoline and the nature of hydrocarbons. Then it explains the various refining steps and how the resulting products are blended to create a finished gasoline. Finally, it describes gasoline specification properties and the tests used to measure them.

## COMPOSITION

There are two ways to describe a material, by its chemical composition and by its properties. Both viewpoints can be instructive. Gasoline is a complex mixture of hundreds of hydrocarbons that vary by class, including paraffins, olefins, naphthenes, and aromatics. Within each class, hydrocarbons also vary by size. The mixture of hydrocarbons (and oxygenates) in a gasoline determines its physical properties and engine performance characteristics.

Gasoline is manufactured to meet property limits prescribed by specifications and regulations, not to achieve a specific distribution of hydrocarbons by class and size. To varying degrees, property limits define chemical composition. Consider, for example, gasoline volatility. Chapter 1, “Gasoline and Driving Performance,” explains that gasoline boils (distills) over a range of temperatures (its distillation profile) and that gasoline specifications limit this range. Each individual hydrocarbon boils at a specific temperature, or *boiling point*, and in general, the boiling point increases with molecular size. Consequently, requiring a distillation profile is equivalent to requiring a population of hydrocarbons with a range of sizes. The temperature limits of a distillation profile exclude smaller hydrocarbons with lower boiling points and larger hydrocarbons with higher boiling points.

The most common way to characterize the size of a molecule is *molecular weight*. For a hydrocarbon, an alternate method is by carbon number, that is, the number of carbon atoms in its molecular structure. Butane, for example, has a molecular weight of 58 grams per gram-mole (g/g-mole) and a carbon number of 4 ( $C_4$ ). Benzene has a molecular weight of 78 g/g-mole and a carbon number of 6 ( $C_6$ ).

Figure 3.1 shows the carbon number distributions for typical regular unleaded and premium unleaded gasolines. Note that the range of sizes runs from  $C_4$  to  $C_{12}$  with the most prevalent size being  $C_5$  for regular and  $C_8$  for premium and the average size being  $C_{6.9}$  for regular and  $C_{7.1}$  for premium. The average molecular weight of gasoline ranges from 92 to 95. Figure 3.2 shows, as expected, that gasoline’s cumulative carbon number distribution parallels the distillation profile.

Figure 3.1

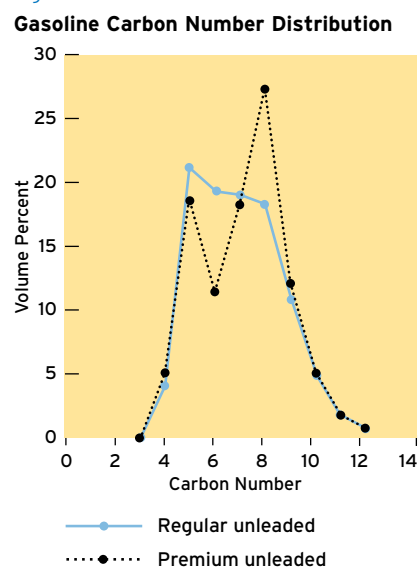

Figure 3.2

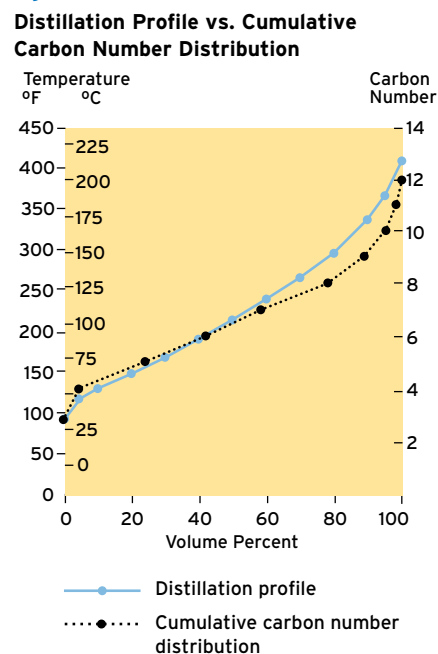

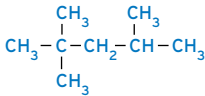
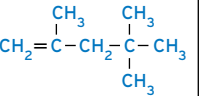
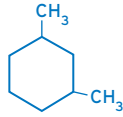
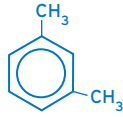

Table 3.1

Research Octane Number by Hydrocarbon Structure

<b>Compound</b>	n-Hexane	1-Hexene	Cyclohexane	Benzene
<b>Formula</b>	$C_6H_{14}$	$C_6H_{12}$	$C_6H_{12}$	$C_6H_6$
<b>Structure</b>	$CH_3(CH_2)_4CH_3$	$CH_2=CH(CH_2)_3CH_3$		
<b>RON</b>	25	76	83	123 (est.)
<b>Compound</b>	2,2,4-Trimethylpentane (Isooctane)	2,4,4-Trimethyl-1-pentene (Isooctene)	Cis 1,3-dimethyl-cyclohexane	1,3-Dimethylbenzene
<b>Formula</b>	$C_8H_{18}$	$C_8H_{16}$	$C_8H_{16}$	$C_8H_{10}$
<b>Structure</b>				
<b>RON</b>	100	106	72	118

Octane number is another example of how property limits define chemical limits. Table 3.1 illustrates how Research octane number (RON) varies with class for hydrocarbons of the same carbon number. So, an octane number limit requires greater representation of some classes and less of others. Octane number differentiation goes beyond class, however. Different isomers of the same hydrocarbon can have different octane numbers. The RON of isooctane (2,2,4-trimethylpentane) is 100 by definition while the RON of normal octane is estimated to be less than zero. Other properties, such as volatility, also are influenced by isomer structure.

With the advent of air pollution regulations throughout the world, property specifications have been supplemented by some composition specifications. For instance, as shown in Figure 2.5, California's first gasoline-related air pollution regulation limited the amount of olefins in gasoline by establishing a maximum Bromine Number specification. (Bromine Number is a measure of olefins in gasoline). In California and elsewhere, more recent regulations limit the amounts of both olefins and aromatics in reformulated gasolines (RFG). See "Olefins" and "Aromatics" on page 26.

Gasolines contain small amounts of compounds (less than 0.1 volume percent) with sulfur, nitrogen, and oxygen atoms in their structures, excluding added oxygenates. Even though these compounds are also composed primarily of carbon and hydrogen atoms, they are not classified as hydrocarbons because of the presence of the other atoms. The compounds either originate in the crude or are formed by the refining processes. Refining destroys many

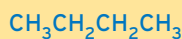
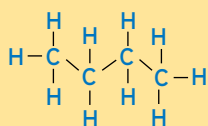

**Butane**

Shorthand

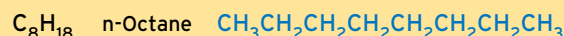
**Structural Isomers****Isooctane**

(2,2,4-Trimethylpentane)

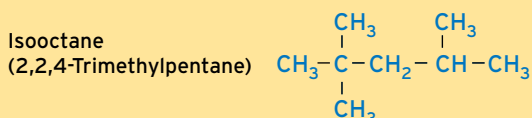
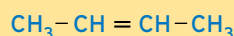
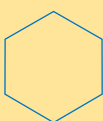
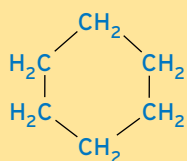
**2-Butene****Cyclohexane**

Shorthand

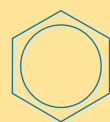
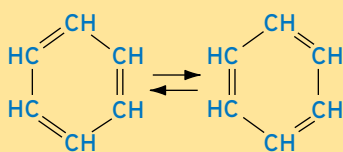
**Benzene**

Shorthand

**About Hydrocarbons**

Hydrocarbons are organic compounds composed entirely of carbon and hydrogen atoms. Each of the four major classes of hydrocarbons – paraffins, olefins, naphthenes, and aromatics – represents a family of individual hydrocarbons that share a structural feature. The classes differ in the ratio of hydrogen to carbon atoms and the way the carbon atoms are bonded to each other.

**Paraffins** Paraffins have the general formula  $C_nH_{2n+2}$ , where  $n$  is the number of carbon atoms. The carbon atoms in paraffins are joined by single bonds and are arranged in a zigzag pattern, but the molecules usually are represented by a shorthand linear structure.

It is possible for paraffins with four or more carbon atoms to exist as two or more distinct compounds that have the same number of carbon and hydrogen atoms. These compounds, called structural isomers, differ in the arrangement of the carbon atoms. Normal octane (*n*-octane) and isooctane are two examples of eight-carbon structural isomers. Isooctane is the common name for 2,2,4-trimethylpentane, which specifies the branching pattern of the three methyl groups on a pentane backbone.

**Olefins** Olefins ( $C_nH_{2n}$ ) are similar to paraffins but have two fewer hydrogen atoms and contain at least one double bond between carbon atoms. They rarely occur naturally in crude oil but are formed during refining. Like paraffins, olefins with four or more carbons can exist as structural isomers.

**Naphthenes** In naphthenes, also called cycloalkanes and cycloparaffins, some of the carbon atoms are arranged in a ring. The naphthenes in gasoline have rings of five and six carbon atoms. Naphthenes have the same general formula as olefins,  $C_nH_{2n}$ . As with normal paraffins, the carbon atoms in cycloparaffins naturally arrange themselves in a zigzag pattern, but the molecule usually is drawn as the planar structure in a shorthand notation that indicates the bonds but omits the carbon and hydrogen atoms.

**Aromatics** Like naphthenes, some of the carbon atoms in aromatics are arranged in a ring, but they are joined by aromatic bonds, not single bonds. The structure can be envisioned as an average of two discrete cyclohexatriene molecules, as it was thought to be in the early days of organic chemistry. The aromatic bond character is now known to be distributed evenly around the ring. The shorthand representation for a monocyclic aromatic ring is a hexagon with a circle inside representing the aromatic bonds.

Aromatic rings always contain six carbons. In polycyclic aromatics, such as naphthalene, some of the carbons are shared by two or more rings.

### Continuous Processing

The change from a batch to a continuous flow process was a major step in the evolution of petroleum refining. Today, almost all processes are continuous flow because it would be impossible for a modern refinery to process the current volume of crude using batch processes.

nitrogen- and, particularly, sulfur-containing compounds, but some survive. Reducing the sulfur content of gasoline is required by California Phase 3 RFG regulations and by U.S. Environmental Protection Agency (EPA) Tier 2 sulfur regulations, and it is a major factor in complying with U.S. EPA Tier 2 and California vehicle emissions regulations.

## REFINING

### Raw Material

As it comes out of the ground, petroleum crude can be as thin and light-colored as apple cider or as thick and black as melted tar. Thin (low-density) crudes have high American Petroleum Institute (API) gravities and therefore are called *high-gravity* crudes; conversely, thick (high-density) crudes are *low-gravity* crudes. High-gravity crudes contain more natural gasoline, and their lower sulfur and nitrogen contents make them easier to refine. Modern refining processes are now capable of turning low-gravity crudes into high-value products such as gasoline. Outside of the U.S., *light crude* refers to a low-density crude and *heavy crude* to a high-density crude oil.

All crudes are composed primarily of hydrocarbons of the paraffinic, naphthenic, and aromatic classes. Each class covers a very broad range of molecular weights.

### Refining Processes

Today's refinery is a complex combination of interdependent processing units, the result of a fascinating intertwining of advances in chemistry, engineering, and metallurgy. Refining started with the simple physical separation process called *distillation*.

**Distillation** In the late 1800s, crude was separated into different products by boiling. As a means for isolating petroleum contents, distillation works because crudes are composed of hydrocarbons with a broad range of molecular weights and, therefore, a broad range of boiling points. Each product was assigned a temperature range and the product was obtained by condensing the vapor that boiled off in this range at atmospheric pressure (*atmospheric distillation*). The earliest distillation process simply involved a container in which crude was heated and an attached condenser to condense vapor. Later, distillation became a continuous process with a pump to provide crude flow, a furnace to heat crude oil, and a distillation column to separate different boiling cuts.

In a distillation column, the vapor of the lowest-boiling hydrocarbons, propane and butane, rises to the top. The *straight-run* gasoline (also called *naphtha*), kerosene, and diesel fuel cuts are drawn off at successively lower positions in the column (see Figure 3.3).<sup>1</sup> Hydrocarbons with boiling points higher than diesel fuel aren't vaporized; called *atmospheric bottoms*, they remain in liquid form and fall to the bottom of the column.

Initially, atmospheric bottoms were used for paving and sealing. Later it was discovered that distilling atmospheric bottoms in a vacuum yielded higher-value products such as

<sup>1</sup> Straight-run products are those isolated from crude by simple distillation.

lubricating oil and paraffin wax. *Vacuum distillation* requires sturdier stills to withstand the pressure differential and entails more sophisticated control systems.

The limits of distillation as the sole refining process were quickly recognized. Since the yield of each product is determined by the quantity of the hydrocarbons in its boiling range in the crude, distillation couldn't produce enough gasoline to meet demand. Furthermore, there was no market for the higher-boiling material.

Figure 3.3

## The Modern Refinery

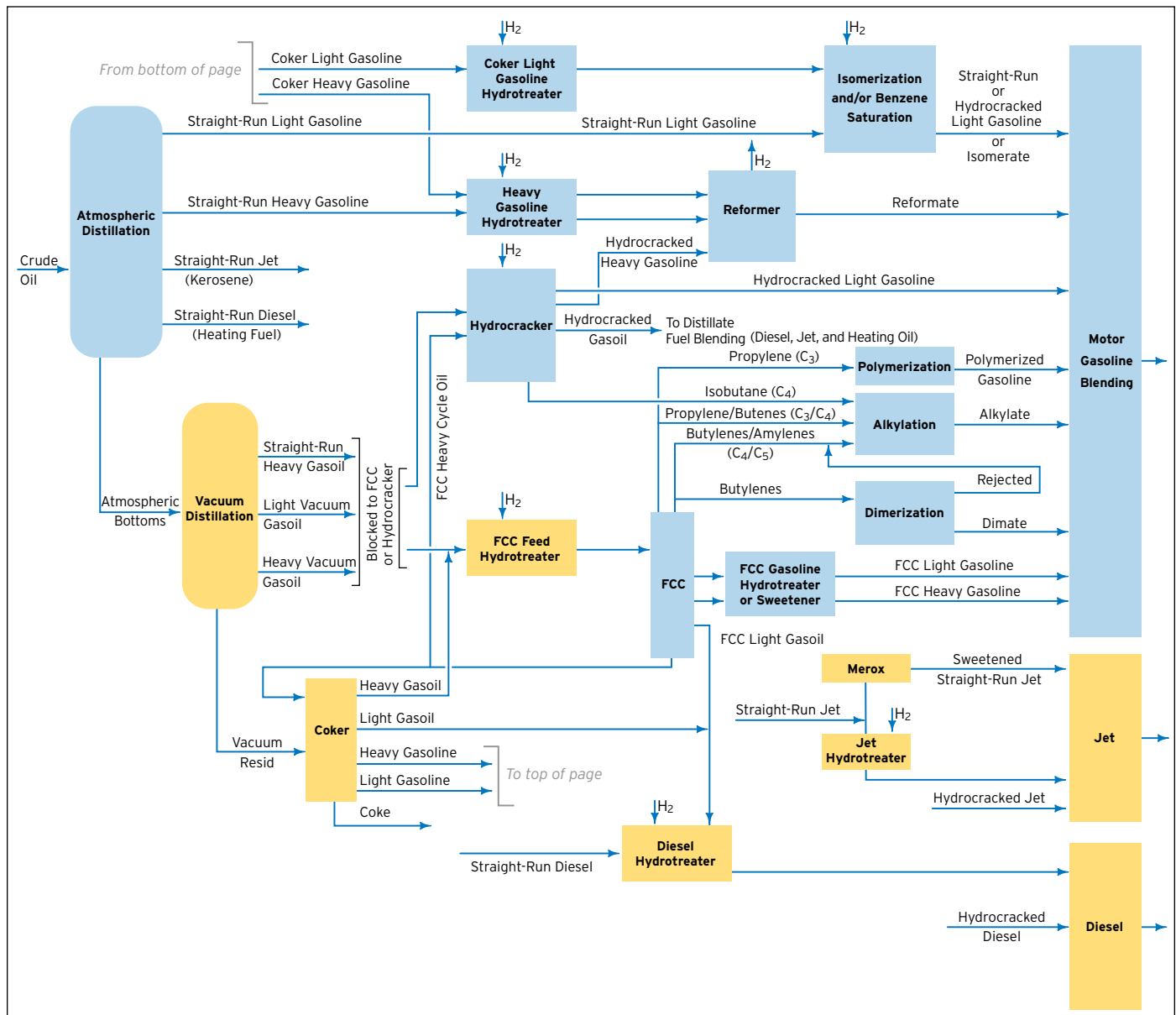

---

**Cracking** The discovery that hydrocarbons with higher boiling points (the larger ones left in the distillation bottoms) could be broken down (*cracked*) into lower-boiling hydrocarbons by subjecting them to very high temperatures offered a way to correct the mismatch between supply and demand. This process, known as *thermal cracking*, was used to increase gasoline production starting in 1913. It is the nature of thermal cracking to make a lot of olefins, which have higher octane numbers but may cause engine deposits. By today's standards, the quality and performance of this early cracked gasoline was low, but it was sufficient for the engines of the day.

Two common examples of thermal cracking still in use today are *visbreaking* and *delayed coking*. Visbreaking heats a heavy petroleum fraction just enough to break down large molecules but not enough to carbonize it. The process is used more prevalently in Europe than in the United States. In delayed coking, petroleum residues are heated enough to cause carbonization. Both thermal processes produce highly olefinic, high-sulfur, high-nitrogen products in the gasoline range and must be further processed to be acceptable motor gasoline blend components.

Eventually heat was supplemented by a *catalyst*, transforming thermal cracking into *catalytic cracking*. A catalyst is a material that speeds up or otherwise facilitates a chemical reaction without undergoing a permanent chemical change itself. Catalytic cracking produces gasoline of higher quality than thermal cracking. There are many variations on catalytic cracking, but *fluid catalytic cracking* (FCC) is the heart of gasoline production in most modern refineries. The term comes from the practice of *fluidizing* a solid catalyst so that it can be continuously cycled from the reaction section of a cracker to the catalyst regeneration section and back again. The FCC process also produces building blocks for other essential refinery processes such as alkylation.

*Hydrocracking* is similar to catalytic cracking in that it uses a catalyst, but the catalyst is in a hydrogen atmosphere. Hydrocracking can break down hydrocarbons that are resistant to catalytic cracking alone. This process is more commonly used to produce diesel fuel than gasoline.

The next group of processes increases a refinery's octane number pool. Although these processes predate the regulation of antiknock additives, they became more important as lead was phased out of gasoline. Without antiknock additives, the only way to produce high-octane-number gasolines is to use inherently high-octane hydrocarbons (see Table 3.1) or to use oxygenates, which also have high-octane-number values.

**Reforming** The *reforming* process literally *reforms* feed molecules, converting straight-chain paraffins and naphthenes into aromatics. For example, reforming cyclizes normal heptane (RON = 0) and then abstracts hydrogen to produce toluene (RON = 120). The hydrogen byproduct is almost as important as the octane number upgrade. Hydrogen is an essential ingredient for hydrocracking and hydrofining. Refineries often have hydrogen

deficits that have to be made up by making hydrogen from natural gas (methane) or other hydrogen-rich feeds.

**Alkylation** The *alkylation* process forms liquid hydrocarbons by combining small gaseous hydrocarbons that have boiling points too low for use in gasoline. The feed, which primarily comes from the FCC unit, includes C<sub>4</sub> hydrocarbons such as isobutane and butylenes and sometimes C<sub>3</sub> and C<sub>5</sub> paraffins and olefins. The principal products are high-octane-number isomers of trimethylpentane such as isooctane (RON = 100). Alkylation is a key process for producing RFG because the contents of the other classes of high-octane-number hydrocarbons – olefins and aromatics – are limited by regulation.

**Polymerization** Another combination process is the polymerization of olefins, typically the C<sub>3</sub> olefin (propylene), into a series of larger olefins differing in molecular weight by three carbon atoms – C<sub>6</sub>, C<sub>9</sub>, C<sub>12</sub>, and so on. Polymerization is a less-favored process than alkylation because the products are also olefins, which may have to be converted to paraffins before they are blended into gasoline.

**Isomerization** *Isomerization* increases a refinery's octane number pool by converting straight-chain (typically C<sub>5</sub> and C<sub>6</sub>) paraffins into their branched isomers. For a given carbon number, branched isomers have higher-octane-number values than the corresponding straight-chain isomer.

**Hydrotreating** *Hydrotreating* is a generic term for a range of processes that use hydrogen with an appropriate catalyst to remove impurities from a refinery stream. The processes run the gamut from mild, selective hydrotreating to remove highly reactive olefins to heavy hydrotreating to convert aromatics to naphthenes.

**Desulfurization** Sulfur removal, or *desulfurization*, traditionally has been a specialized example of a hydrotreating process. Meeting ever-decreasing regulatory sulfur limits for RFG may require the desulfurization of a significant proportion of FCC gasoline. There are also processing reasons to desulfurize intermediate refinery streams. In reforming, excess sulfur in the feed deactivates the catalyst. Excess sulfur in the FCC feed results in high levels of sulfur in FCC gasoline and greater production of sulfur dioxide during FCC catalyst regeneration.

Sulfur limits for RFG (and diesel) and for U.S. EPA Tier 2 regulations have prompted the commercialization of several non-hydrotreating processes for sulfur removal. One option is *adsorption*, in which an appropriate adsorbent removes selected sulfur species directly from FCC gasoline. One variation requires chemically changing existing sulfur species to more easily adsorbed species. Another process reacts sulfur species with olefins in the FCC gasoline, producing heavier sulfur species that may be removed by simple distillation. Yet another process variation oxidizes many sulfur species so that they may be removed by water washing.

---

**Etherification of Olefins** High-octane oxygenates called *ethers* may be produced during refining by reacting suitable alcohols such as methanol and ethanol with branched olefins from the FCC, such as isobutene and isopentene, under the influence of acid catalysts. In the mid-1990s methyl tertiary butyl ether (MTBE), made by *etherification* of isobutene with methanol, became the predominant oxygenate used to meet U.S. EPA and California Air Resources Board (CARB) reformulation requirements for adding oxygen to decrease emissions from gasoline-powered vehicles. Today in the U.S., use of MTBE as a gasoline additive is banned in many states over concern for potential groundwater contamination, so most MTBE plants have been shut down or converted for other uses. (See sections in Chapter 2, “Gasoline and Air Quality,” and in Chapter 4, “Oxygenated Gasoline,” for more detail pro and con.)

**Isobutene Dimerization** Possible environmental issues with MTBE have made it more desirable to dimerize isobutene from the FCC unit rather than etherify it. Fortunately, isobutene *dimerization* may be done with minimal modifications to existing MTBE plants and process conditions, using the same acidic catalysts. Where olefin levels are not restricted, the extra blending octane boost of the *di-isobutylene* can be retained. Where olefin levels are restricted, the di-isobutylene can be hydrotreated to produce a relatively pure isooctane stream that can supplement alkylate for reducing olefins and aromatics in RFG.

### The Modern Refinery

The schematic layout of a modern, fully integrated U.S. refinery is shown in Figure 3.3. Crude oil is fed to the distillation column where straight-run light and heavy gasoline, jet, and diesel are separated at atmospheric pressure. Straight-run jet fuel is usually acceptable as is, straight-run diesel fuel requires further hydrotreatment to remove sulfur, and straight-run gasolines typically require more processing to convert them into gasoline blending components. Straight-run light gasoline may be isomerized to increase octane number, hydrotreated to convert benzene to cyclohexane so that the final gasoline blend will meet a benzene specification limit, or both. Straight-run heavy gasoline is hydrotreated to remove sulfur and then reformed to improve octane number and generate hydrogen for the hydrotreaters.

The bottoms from the atmospheric column are vacuum-distilled to obtain *gasolins* for FCC or hydrocracker feed. The gasolins are hydrotreated to reduce sulfur and nitrogen to levels that will not interfere with the FCC process. Even though the feed is substantially desulfurized, the FCC product must be *sweetened* to convert reactive sulfur compounds (*mercaptans*) to more innocuous ones; otherwise, the gasoline blend will be odorous and unstable. In California and for areas meeting U.S. EPA Tier 2 standards, the FCC product must be further desulfurized.

Previously, the *vacuum resid* might have been used as low-value, high-sulfur fuel oil for onshore power generation or marine fuel. Now, to remain competitive, refiners wring as



much high-value product as possible from every barrel of crude. As a result, the vacuum resid is sent to a *resid conversion* unit, such as a resid cracker, solvent extraction unit, or coker. These units produce more transportation fuel or gasoil, leaving an irreducible minimum of resid or coke. The resid-derived streams require further processing or treating or both before they can be blended into light fuels such as gasoline or diesel.

The complex refinery shown in Figure 3.3 contains processing units that are not in all refineries in the U.S. or in the world. Many simple refineries consist of only a distillation unit and a reformer. Others also have an FCC unit and an alkylation unit. There are many combinations of units in refineries throughout the world. A refinery's selection of processing units depends on the product volumes for the marketplace it serves. If diesel fuel is a larger part of the market than gasoline, processing units will be selected to maximize production of diesel fuel.

### Processing Changes Required by Air Pollution Regulations

The balance among the various processes in a refinery is dynamic, responding both to external and internal developments. The impact of air pollution regulations (see Figure 2.5) is a good example of external requirements for change in refinery operations. The requirement for unleaded gasoline and the gradual increase of its sales roughly paralleled the gradual phase-down of lead in leaded gasoline. Both these trends increased the need for higher-octane-number components. In response, refiners produced more reformat, FCC gasoline, alkylate, and oxygenates, roughly in this order. Later, tighter and tighter vapor pressure limits forced the reduction of the amount of butane that could be added to gasoline in the summer. This resulted in excess butane, and because butane has good octane quality, its reduction further increased the need for higher-octane-number components.

A solution for both problems was to use butane to make alkylate. The requirements for oxygenated gasoline helped the octane number shortfall because oxygenates have high octane numbers. The need for oxygenates prompted some refiners to add units to make MTBE and other ethers. More recently, the advent of California Phase 2 and Phase 3 RFG requirements placed new restrictions on olefins, aromatics, heavy ends (high boiling point molecules), and sulfur. This required more hydrotreating, alkylation, and cracking capability. The investment to make all these changes is in the tens of billions of dollars, nearly equaling the capitalization of the refining industry at the beginning of the RFG era. Now, with ever-decreasing regulatory sulfur limits in the U.S. and Europe, additional sulfur reduction units have been installed. Desulfurization of gasoline blending streams is sometimes required in addition to severe hydrotreating of FCC feed to meet the required low sulfur content limits. Severe conventional hydrotreating can result in a loss in octane number because of saturation of high-octane-number olefins and aromatics. New versions of hydrotreaters do not cause as much of an octane number loss. New refinery processes for removing sulfur do not involve the use of hydrogen (see page 37).

---

## BLENDING

Despite the diversity and ingenuity of the processes within a modern petroleum refinery, no single stream meets all the requirements of gasoline. Thus, the final step in gasoline manufacture is blending various streams into a finished product. It is not uncommon for finished gasoline to be made up of six or more streams (see Figure 3.3). Sometimes, to provide more flexibility, a stream is distilled into several fractions and each fraction is used as a separate blending component (for example, FCC light and FCC heavy gasoline).

Several factors make this flexibility critical:

- Gasoline specifications (ASTM D4814) and regulations are complex.
- Different marketing locations served by the refinery may have different performance and regulatory specifications that may also vary seasonally (see Chapter 1, “Gasoline and Driving Performance,” and Chapter 2, “Gasoline and Air Quality”).
- A blend must satisfy multiple internal inventory and economic requirements.

To help obtain an on-test blend, on time, every time, refiners use computerized blending programs to generate an optimized blend recipe. A computer program integrates all the performance, regulatory, economic, and inventory requirements.

## CONTAMINATION AND ADULTERATION

During manufacturing and distribution, gasoline comes into contact with water and particulate matter and can become contaminated with such materials. Water is allowed to settle from fuel in storage tanks and is regularly withdrawn. Particulate matter is removed by filters installed in the distribution system. Appendix X6 of ASTM D4814 recommends the installation of filters of 10 micrometers ( $\mu\text{m}$ ) or less nominal pore size on all dispensers delivering fuel to the customer.

Adulteration differs from contamination in that unacceptable materials are deliberately added to gasoline. It may be as simple as adding regular-grade gasoline to a premium-grade gasoline storage tank, which lowers the octane number of the premium. Adding low-taxed or subsidized kerosene to gasoline lowers the octane number of the mix and adversely affects its volatility, which affects driveability. Used toluene containing soluble silicon compounds from manufacturing processes is another adulterant that has been found in gasoline. In vehicle engines, the silicon fouls oxygen sensors and plugs exhaust catalysts, causing severe performance problems and necessitating expensive repairs. In some countries, dyes and markers are used to detect adulteration. ASTM D86 distillation testing and/or ASTM D2699/ASTM D2700 octane number testing may be required to detect adulteration.

## GASOLINE ADDITIVES

Additives are gasoline-soluble chemicals mixed with gasoline to enhance certain performance characteristics or to provide characteristics not inherent in the gasoline. Typically, they are derived from petroleum-based raw materials and their function and chemistry are highly specialized. They produce the desired effect at the parts-per-million (ppm) concentration range. (One ppm is 0.0001 mass percent or 1mg/kg.)

**Oxidation inhibitors**, including aromatic amines and hindered phenols, are also called antioxidants. They prevent gasoline components from reacting with oxygen in the air to form *peroxides* or *gums*. They are needed in virtually all gasolines but especially in those with high olefin content. Peroxides can degrade antiknock quality, cause fuel pump wear, and attack plastic or elastomeric fuel system parts. Soluble gums can lead to engine deposits, and insoluble gums can plug fuel filters. Inhibiting oxidation is particularly important for fuel used in modern fuel-injected vehicles because those with fuel recirculation design may subject the fuel to more temperature and oxygen-exposure stress.

**Corrosion inhibitors** are carboxylic acids and carboxylates. The tank and pipeline facilities of gasoline distribution and marketing systems are constructed primarily of uncoated steel. Corrosion inhibitors help prevent free water in gasoline from rusting or corroding these facilities. Corrosion inhibitors are less important once gasoline is in a vehicle. The metal parts in the fuel systems of today's vehicles are made of corrosion-resistant alloys or of steel that is covered with a corrosion-resistant coating. More plastic and elastomeric parts are replacing metal parts in fuel systems. In addition, service station systems and operations are designed to help prevent free water from being delivered to vehicle fuel tanks.

**Silver corrosion inhibitors** are substituted thiadiazole. Combinations of trace amounts of elemental sulfur, hydrogen sulfide, and mercaptans can cause the silver used in vehicle fuel gauge sender units to corrode and fail. Silver corrosion inhibitors, also referred to as filmers, inhibit the corrosion caused by active sulfur compounds.

**Metal deactivators** are *chelating agents*, that is, chemical compounds that capture specific metal ions. The more active metals such as copper and zinc effectively catalyze the oxidation of gasoline. These metals are not used in most gasoline distribution and vehicle fuel systems, but when they are present, metal deactivators inhibit their catalytic activity.

**Demulsifiers** are polyglycol derivatives. An *emulsion* is a stable mixture of two mutually insoluble materials. A gasoline/water emulsion can be formed when gasoline passes through the high-shear field of a centrifugal pump if the gasoline is contaminated with free water. Demulsifiers improve the water-separating characteristics of gasoline by preventing the formation of stable emulsions.

### Density and Gravity

Density ( $\rho$ ) is mass per unit volume of a material at a selected temperature. For example, the density of water is 0.9990 grams per cubic centimeter ( $\text{g}/\text{cm}^3$ ) at 15.6°C (60°F). Relative density (RD), also called **specific gravity**, is the ratio of the density of a material at a selected temperature to the density of a reference material at a selected temperature. For the relative density of petroleum crudes and products in the U.S., the reference material is water and the temperatures is 15.6°C (60°F).

$$\text{RD (60/60°F)} = \frac{\rho \text{ sample (60°F)}}{\rho \text{ water (60°F)}}$$

The U.S. petroleum industry often uses **API gravity** instead of relative density. The following equation relates API gravity, in degrees API ( $^{\circ}\text{API}$ ), to relative density.

$$^{\circ}\text{API} = \frac{141.5}{\text{RD (60/60°F)}} - 131.5$$

While API gravity measurements may be made on liquids at temperatures other than 15.6°C (60°F), the result is always converted to the value at 15.6°C (60°F), the standard temperature. As the above formula indicates, API gravity is inversely proportional to relative density: API gravity increases as relative density decreases. Thus, a high-gravity crude has a lower density than a low-gravity crude. Outside the U.S., density (usually at 15°C and expressed as  $\text{kg}/\text{m}^3$ ) rather than API gravity or relative density is usually used to describe crude oils and petroleum products.

---

**Antiknock compounds** increase the antiknock quality of gasoline. They include materials based on:

- Lead alkyls, such as tetraethyl lead (TEL) and tetramethyl lead (TML)
- Manganese, called methylcyclopentadienyl manganese tricarbonyl (MMT)
- Iron, called ferrocene

Because only a small amount of additive is needed, using antiknock compounds is a lower-cost method to increase octane number than changing gasoline chemistry.

Gasoline containing TEL was first marketed in 1923. The average concentration of lead in gasoline gradually was increased until it reached a maximum of about 660 milligrams per liter (mg/L) or 2.5 grams per gallon (g/gal) in the late 1960s. After that, a series of events resulted in the use of less lead. First, new refining processes produced higher-octane gasoline components. Then, the population of vehicles that require unleaded gasoline – those with catalytic exhaust emission controls – steadily grew. Last, U.S. EPA regulations required the reduction of the lead content of gasoline in phased steps beginning in 1979. The U.S. EPA completely banned the addition of lead additives to on-road gasoline in 1996. Currently, the amount of incidental lead may not exceed 13.2 mg/L (0.05 g/gal) and cannot be deliberately added.

MMT was commercialized in 1959 and was used in gasoline alone or in combination with lead alkyls. The U.S. Clean Air Act Amendments of 1977 banned the use of manganese antiknock additives in unleaded gasoline unless the U.S. EPA granted a waiver. MMT continued to be extensively used in unleaded gasoline in Canada at concentrations up to 18 mg/L (0.068 g/gal) until 2004 when it was voluntarily removed. In 1996, after several waiver requests and court actions by the manufacturer, the courts ordered the U.S. EPA to grant a waiver for MMT. Its use is limited to a maximum of 8.2 mg/L (0.031 g/gal). California regulations continue to ban the addition of manganese to gasoline.

MMT's future in the U.S. is clouded. Its use in gasoline is opposed by environmental groups and automobile manufacturers. Gasoline containing MMT leaves significant red-orange deposits on spark plugs, catalytic converters, oxygen sensors, and combustion chamber walls. The additive manufacturer has developed a large body of data to help support its claim that MMT in gasoline does not reduce performance or increase emissions.

However, auto manufacturers have expressed concerns about shortened catalyst, oxygen sensor, and spark plug life and interference with on-board diagnostic (OBD) system performance (see page 72). In an auto industry test involving a large number of vehicles, fuel containing MMT was shown to increase HC emissions in exhaust. Increases in other emissions were observed at high mileages in some vehicles designed to meet low-emission

limits. In addition, there have been reports of plugging of high-density honeycomb monolith catalyst systems on vehicles operating on gasoline containing MMT. Nevertheless, the additive manufacturer takes exception to the auto manufacturers' test results and their concerns over catalyst plugging. Some new vehicle owner's manuals recommend against using gasoline containing MMT. Very little MMT is being used in gasoline sold in the U.S. at this time.

In many parts of the world, lead antiknocks are being eliminated from gasoline used in vehicles that do not have catalytic exhaust emission controls and therefore do not require unleaded gasoline. This grade of lead-free gasoline frequently is referred to as *lead replacement petrol* (LRP), and it may contain a special additive to help protect engines susceptible to exhaust-valve recession. However, refineries that do not have the processing capability to produce the required octane quality without an antiknock additive may use MMT because it can enhance octane quality and provide some protection against exhaust-valve recession. The auto industry also opposes the use of MMT in this gasoline because of concern that LRP may find its way into catalyst-equipped vehicles. To help prevent misfueling, gas stations usually dispense LRP through gas pumps with nozzles that are wider than the fuel tank openings on catalyst-equipped vehicles.

Ferrocene (dicyclopentadienyl iron) has been around for nearly 50 years. It has not been widely marketed as an antiknock compound, although it has seen limited use in Europe. When combusted, it forms ferric oxides (also known as jeweler's rouge), a fine abrasive. Early studies of ferrocene showed excessive piston ring, cylinder bore, and camshaft engine wear at the concentrations investigated. Recent auto industry studies involving lower iron concentrations have shown premature spark plug failures at the current recommended concentration of 30 ppm ferrocene (9 ppm iron). Concern also has been expressed that ferric oxide will act as a physical barrier on oxygen sensors and exhaust catalyst surfaces and possibly cause catalyst plugging in modern vehicles. In the U.S., ferrocene cannot be used in RFG because of a ban on the use of heavy metals. Further, it cannot be used in conventional gasoline without obtaining a waiver from the U.S. EPA.

**Deposit control additives** See Chapter 6, "Gasoline Vehicles – Deposit Control."

**Anti-icing additives** are surfactants, alcohols, and glycols. They prevent ice formation in the carburetor and fuel system (see page 4). The need for this additive is disappearing as older-model vehicles with carburetors are replaced by vehicles with fuel injection systems.

**Dyes** are oil-soluble solids and liquids used to visually distinguish batches, grades, or applications of gasoline products. For example, gasoline for general aviation, which is manufactured to unique and exacting requirements, is dyed blue to distinguish it from motor gasoline.

---

**Markers** are a means of distinguishing specific batches of gasoline without providing an obvious visual clue. A refiner may add a marker to its gasoline so it can be identified as it moves through the distribution system.

**Drag reducers** are high-molecular-weight polymers that improve the fluid flow characteristics of low-viscosity petroleum products. As energy costs have increased, pipelines have sought more efficient ways to ship products. Drag reducers lower pumping costs by reducing friction between flowing gasoline and pipe walls.

## SPECIFICATIONS

It has been critical to the successful development of gasoline and gasoline-powered vehicles to have consensus among refiners, vehicle manufacturers, and other interested parties on the characteristics of gasoline necessary for satisfactory performance and reliable operation. This consensus is reached in the U.S. under the auspices of ASTM International (formerly the American Society for Testing and Materials). Many countries prescribe gasoline specifications that control properties similar to those specified in ASTM D4814. For instance, in Canada, the Canadian General Standards Board (CGSB) functions like ASTM International and issues CGSB 3.5-2004 for unleaded gasoline and CGSB 3.511-2005 for ethanol blends. The Comité Européen de Normalisation (CEN, also known as the European Committee for Standardization) issues specifications that are translated by country, including BS EN 228 (UK), NF EN 228 (France), DIN EN 228 (Germany), DS/EN 228 (Denmark), NS-EN 228 (Norway), and UNI EN 228 (Italy). The Japan Standards Association (JSA) issues gasoline specification JIS K 2202 and test methods. Test methods in Europe are supported by CEN, the International Organization for Standardization (ISO), and national institutes such as Deutsches Institut für Normung (DIN, of Germany), L'Association Française de Normalisation (AFNOR, of France), and BSI British Standards.

ASTM International Committee D02 on Petroleum Products and Lubricants is responsible for gasoline specifications and test methods. A large number of groups are interested in or affected by the specifications. Their viewpoints are brought to the D02 forum by representatives who also are members of ASTM International, including:

- Individual refiners
- API, an association of petroleum refiners
- Petroleum marketing organizations
- Pipeline companies
- Vehicle and engine manufacturers



- Alliance of Automobile Manufacturers, an association of vehicle manufacturers
- Automotive equipment suppliers
- Renewable Fuels Association
- Governmental regulatory agencies such as the U.S. EPA, CARB, and state weights-and-measures agencies
- Independent research laboratories and consultants
- SAE International (formerly the Society of Automotive Engineers)
- Coordinating Research Council (CRC), which directs engineering and environmental studies on the interaction between automotive equipment and petroleum products

The ASTM specification for gasoline, D4814 – *Standard Specification for Automotive Spark-Ignition Engine Fuel*, is widely recognized. It has been written into U.S. gasoline regulations, both federal and state.

D4814 specifies 10 gasoline properties (Table 3.2). These do not include octane number or antiknock index, which are set by gasoline refiners and marketers “based on their perception of the technical and competitive needs in the market.”<sup>2</sup>

D4814 references more than 30 other ASTM standards that describe how to sample gasoline and how to run specific test methods. These associated methods are essential. Specifying a property has no value unless everyone measuring the property uses the same procedure and, for a given material, gets the same answer within the defined precision. D4814 also contains an annex and eight appendices, including one that discusses the significance of specifications and another that summarizes the U.S. EPA’s gasoline regulations.

The U.S. EPA and some states set additional standards for gasoline. These are not included in D4814 unless they involve properties traditionally covered by the method (such as vapor pressure). ASTM revises D4814 to conform to such regulations if they have been approved by the U.S. EPA.

Table 3.2

ASTM D4814 Properties

Property	Intent
<b>Schedule of Seasonal and Geographic Volatility Classes, which includes:</b> Vapor Pressure/Distillation Class Vapor Lock Protection Class	To enable good driveability. (See Chapter 1, “Gasoline and Driving Performance.”)
<b>Solvent-Washed Gum Content</b>	To protect against the presence of gums formed by oxidation, which can contribute to fuel system deposits.
<b>Oxidation Stability</b>	To protect against the formation of additional gum by air oxidation during storage.
<b>Water Tolerance</b>	To protect against the phase separation of dissolved water at colder temperatures. Not usually a problem for hydrocarbon blends but can be for some oxygenated blends (see page 58).
<b>Sulfur Content</b>	To protect against engine wear, deterioration of engine oil, corrosion of exhaust system parts and a temporary reduction in the efficiency of the converter catalyst.
<b>Copper Strip Test</b>	To protect against corrosion of fuel system parts due to reactive sulfur compounds.
<b>Silver Strip Corrosion</b>	To protect against silver fuel gauge corrosion.
<b>Lead Content</b>	To help ensure that unleaded gasolines are free of lead.
<b>Appearance</b>	To help ensure product is visually free of undissolved water, sediment, and suspended matter.
<b>Workmanship</b>	To be free of adulterant or contaminant that may render the fuel unfit for purpose.

<sup>2</sup> ASTM International, ASTM D4814 *Standard Specification for Automotive Spark-Ignition Engine Fuel*, [www.astm.org](http://www.astm.org).

---

Each gasoline refiner, each pipeline that ships gasoline, some states, and even automobile manufacturers may set additional internal specifications beyond ASTM D4814 or may set more or less stringent limits for the D4814 properties. However, except in the case of internal refining specifications, these limits will not prevail unless all interested parties recognize their value.

The U.S. federal government and the state of California set limits on RFG to help control emissions and specify approved test methods to determine compliance. Terminology, requirements, test methods, applicable areas, and discussion of RFG for both U.S. and California programs are summarized in ASTM Research Report D02:1347 – *Research Report on Reformulated Spark-Ignition Engine Fuel*.

Table 3.3 contains a list of the test methods approved for determining motor gasoline properties.

Table 3.3

**Motor Gasoline Test Methods**

These methods originate with ASTM International, 100 Barr Harbor Drive, P.O. Box C700, West Conshohocken, Pa., [www.astm.org](http://www.astm.org).

Property	Standard Test Method	Description
<b>Vapor Pressure</b>	ASTM D323 – <i>Vapor Pressure of Petroleum Products (Reid Method)</i>	In all six methods, a chilled, fixed volume of gasoline is placed in a test chamber and heated to 37.8°C (100°F). Then the pressure developed by gasoline vapors is measured in units of psi or kPa.
	ASTM D5190 – <i>Vapor Pressure of Petroleum Products (Automatic Method)</i>	The methods differ in the design of the apparatus, including the design of the test chamber. D323 yields <i>Reid vapor pressure (RVP)</i> , and the other methods yield <i>dry vapor pressure equivalent (DVPE)</i> .
	ASTM D5191 – <i>Vapor Pressure of Petroleum Products (Mini Method)</i>	ASTM D323 cannot be used to measure the vapor pressure of gasoline containing ethanol and therefore is no longer recognized by ASTM D4814.
	ASTM D4953 – <i>Vapor Pressure of Gasoline and Gasoline-Oxygenate Blends (Dry Method)</i>	
	ASTM D5482 – <i>Vapor Pressure of Petroleum Products (Mini Method – Atmospheric)</i>	
	ASTM D6378 – <i>Vapor Pressure (VP<sub>x</sub>) of Petroleum Products, Hydrocarbons, and Hydrocarbon-Oxygenate Mixtures (Triple Expansion Method)</i>	
<b>Octane Number</b>	ASTM D2699 – <i>Research Octane Number of Spark-Ignition Engine Fuel</i>	Both of these test methods employ a CFR single-cylinder, variable-compression, knock-test engine. The engine is operated under different test conditions of speed, mixture temperature, and spark advance for each method. During a gasoline test, the compression ratio of the test engine is adjusted to produce a knock of standard intensity. The knock intensity of the gasoline being rated is then matched to the primary reference fuel at the set compression ratio. The octane number of the reference fuel is assigned as the octane number of the test gasoline. The series of primary reference fuels are blends of normal heptane (octane number defined equal to zero) and isooctane (2,2,4-trimethylpentane, with a defined octane number equal to 100). The octane number of each primary reference fuel is equal to the volume percent of isooctane it contains.
	ASTM D2700 – <i>Motor Octane Number of Spark-Ignition Engine Fuel</i>	
		See Chapter 1, “Gasoline and Driving Performance,” for information on Research octane number (RON), Motor octane number (MON), and antiknock index (AKI) and how these values are used to define the antiknock quality of gasoline.

Property	Standard Test Method	Description
<b>Road Octane Number</b>		<p>Generally, road octane number (RdON) is determined by the CRC's Modified Uniontown Technique F-28-651. In this procedure, a test vehicle is operated on a series of primary reference fuels of increasing octane number under maximum throttle acceleration. (This test cannot be run on modern vehicles that have timing regulated by engine control modules [see page 72].) The basic timing is advanced for each reference fuel until <i>trace knock</i> – the lowest knock level detected by the ear of the person rating the fuel – is detected. The plot of basic spark timing vs. RON provides a <i>primary reference curve</i> for the test car. Then the car is operated on the gasoline to be rated until the spark advance needed to cause trace knock under maximum throttle acceleration is found. The octane number associated with that spark timing advance in the primary reference curve is the RdON of the test gasoline.</p> <p>For a statistically significant determination, 10 to 15 test vehicles (usually different models) must be used because of the numerous variables involved. The RdONs of the individual vehicles are averaged to determine the final RdON of the test gasoline.</p>
<b>Distillation Profile</b>	ASTM D86 – <i>Distillation of Petroleum Products at Atmospheric Pressure</i>	<p>In this test, a 100-milliliter fuel sample is placed in a round-bottom flask and heated to a controlled rate of evaporation. The temperature is recorded when the first drop of condensate falls from the lower end of the condenser tube into the receiving cylinder (the initial boiling point) and then at recovered volume percentages of 5 percent, 10 percent, every increment of 10 percent to 90 percent, 95 percent, and at the end of the test (end point/final boiling point). For gasoline samples, it is possible to correct for any sample loss by converting the temperatures associated with each incremental volume percentage recovered to temperatures for each incremental volume percentage evaporated.</p>

Property	Standard Test Method	Description
<b>Vapor-Liquid Ratio</b>	ASTM D5188 – <i>Vapor-Liquid Ratio Temperature Determination of Fuels (Evacuated Chamber Method)</i>	In D5188, a calculated volume of air-saturated sample (all fuels) at 0°C (32°F) is introduced into an evacuated, thermostatically controlled test chamber of known volume. The sample volume is calculated to obtain the desired V/L ratio in the chamber. After injection, the chamber temperature is adjusted until a stable chamber pressure of 101.3 kPa (760 mm Hg) is achieved.  ASTM D4814, Appendix X2 – Two calculation methods are specified: a computer method and a linear equation method. These methods are used to estimate vapor-liquid ratio (V/L) from vapor pressure and distillation test results and are not applicable for oxygenated gasolines. A procedure for correcting the estimated V/L values for ethanol blends is now part of D4814.
<b>API Gravity (see page 41)</b>	ASTM D1298 – <i>Density, Relative Density (Specific Gravity), or API Gravity of Crude Petroleum and Liquid Petroleum Products by Hydrometer Method</i>	For D1298, the sample is placed in a cylinder and the appropriate hydrometer is lowered into the sample. After temperature equilibrium has been reached, the sample temperature and hydrometer scale reading are recorded. ASTM Petroleum Measurement Tables are used to convert the recorded value to the value at a standard temperature such as 15°C or 60°F.
	ASTM D4052 – <i>Density and Relative Density of Liquids by Digital Density Meter</i>	For D4052, a small volume of liquid sample is introduced into an oscillating sample tube, and the change in oscillating frequency caused by the change in the mass of the tube is used in conjunction with calibration data to determine the density of the sample.
<b>Oxidation Stability (Induction Period)</b>	ASTM D525 – <i>Oxidation Stability of Gasoline (Induction Period Method)</i>	Fifty milliliters of gasoline are placed in a glass sample container in a pressure vessel. Oxygen is introduced to a pressure of about 700 kPa (100 psi). The charged pressure vessel is placed in a 100°C (212°F) bath, and the pressure is continuously monitored. The break point of the fuel is determined to be the point just prior to a specified drop in pressure within a 15-minute interval. The number of minutes to the break point is reported.
<b>Solvent-Washed Gum Content</b>	ASTM D381 – <i>Gum Content in Fuels by Jet Evaporation</i>	Fifty milliliters of gasoline are evaporated under controlled air flow at about 155°C (310°F) for 30 minutes. The residue is weighed before and after extraction with n-heptane. The result is reported as milligrams per 100 mL.

Property	Standard Test Method	Description
<b>Potential Gum</b>	Chevron's test method for determining the gumming potential of a gasoline is based on ASTM D873 – <i>Oxidation Stability of Aviation Fuels (Potential Residue Method)</i> , which combines ASTM D525 – <i>Oxidation Stability of Gasoline (Induction Period Method)</i> and ASTM D381 – <i>Gum Content in Fuels by Jet Evaporation</i> .	One hundred milliliters of gasoline, free of deposit control additive, is oxidized for four hours at 100°C (212°F) in a bomb initially charged with 700 kPa (100 psi) of oxygen. After this treatment, the amount of insoluble gum is collected by filtration and measured. The soluble gum is isolated by ASTM D381 and measured. The total insoluble and soluble gum is reported as potential gum in units of milligrams per 100 mL.
<b>Sulfur Content</b>	<p>ASTM D1266 – <i>Sulfur in Petroleum Products (Lamp Method)</i></p> <p>ASTM D2622 – <i>Sulfur in Petroleum Products by Wavelength Dispersive X-ray Fluorescence Spectrometry</i></p> <p>ASTM D3120 – <i>Trace Quantities of Sulfur in Light Liquid Hydrocarbons by Oxidative Microcoulometry</i></p> <p>ASTM D4045 – <i>Sulfur in Petroleum Products by Hydrogenolysis and Rateometric Colorimetry</i></p> <p>ASTM D4294 – <i>Sulfur in Petroleum and Petroleum Products by Energy-Dispersive X-ray Fluorescence Spectrometry</i></p> <p>ASTM D5453 – <i>Determination of Total Sulfur in Light Hydrocarbons, Spark Ignition Engine Fuel, Diesel Engine Fuel, and Engine Oil by Ultraviolet Fluorescence</i></p> <p>ASTM D6334 – <i>Sulfur in Gasoline by Wavelength Dispersive X-Ray Fluorescence</i></p>	As the names of the sulfur test methods indicate, several technologies are used to determine the sulfur content of gasoline. Some of the methods are applicable only for samples with high sulfur concentration, others cover a broad range of sulfur concentration, and some can be used only for samples with low sulfur concentration. Specific test methods need to be reviewed for applicability before selecting one to use.



Property	Standard Test Method	Description
<b>Sulfur Content</b>	ASTM D6445 – <i>Sulfur in Gasoline by Energy-Dispersive X-ray Fluorescence Spectrometry</i>	
	ASTM D7039 – <i>Sulfur in Gasoline and Diesel Fuel by Monochromatic Wavelength Dispersive X-ray Fluorescence Spectrometry</i>	
<b>Copper Strip Corrosion</b>	ASTM D130 – <i>Detection of Copper Corrosion from Petroleum Products by the Copper Strip Tarnish Test</i>	<p>D130 can be used to detect the presence of free sulfur or reactive sulfur compounds. In this test, a polished copper strip is immersed in 30 milliliters of gasoline and heated to 50°C (122°F) for three hours. The test strip is compared to standard strips and reported on a scale of one to four (one being best).</p> <p>It is becoming clear that as sulfur levels in gasolines are forced lower, many sulfur species that actually provide protection for copper surfaces are being greatly reduced or eliminated. In reformulated gasolines that have extremely low sulfur content, levels of free sulfur or reactive sulfur compounds that would not have caused a failed copper strip test in conventional gasolines may now cause a failure. This factor increases the urgency for minimizing contamination with even minor levels of free sulfur or reactive sulfur compounds in processing at the refinery.</p>
<b>Silver Strip Corrosion</b>	ASTM D4814 Annex A1 – <i>Corrosiveness of Silver From Petroleum Products by Silver Strip Test</i>	This interim test method uses the ASTM D130 test apparatus except a silver coupon replaces the normal copper one and the test is conducted at 37.8°C (100°F) for three hours.
<b>Lead Content</b>	ASTM D3237 – <i>Lead in Gasoline by Atomic Absorption Spectroscopy</i>	These methods are applicable for determining the low levels of lead that may be present in unleaded gasoline.
	ASTM D5059 – <i>Lead in Gasoline by X-Ray Spectroscopy</i>	

Property	Standard Test Method	Description
<b>Oxygenates Content</b>	<p data-bbox="326 512 716 646"><i>ASTM D4815 – Determination of MTBE, ETBE, TAME, DIPE, tertiary-Amyl Alcohol, and C<sub>1</sub> to C<sub>4</sub> Alcohols in Gasoline by Gas Chromatography</i></p> <p data-bbox="326 680 716 821"><i>ASTM D5599 – Determination of Oxygenates in Gasoline by Gas Chromatography and Oxygen Selective Flame Ionization Detection</i></p> <p data-bbox="326 854 716 995"><i>ASTM D5845 – Determination of MTBE, ETBE, TAME, DIPE, Methanol, Ethanol, and tert-Butanol Gasoline by Infrared Spectroscopy</i></p>	<p data-bbox="769 512 1487 646">In addition to using a gas chromatography column, D4815 uses either a flame ionization detector or a thermal conductivity detector and D5599 uses an oxygen-selective flame ionization detector. D5845 uses a mid-infrared spectrometric analyzer to detect oxygenates.</p>
<b>Appearance</b>	<p data-bbox="326 1031 680 1163"><i>ASTM D4176 – Free Water and Particulate Contamination in Distillate Fuels (Visual Inspection Procedures)</i></p>	<p data-bbox="769 1031 1487 1199">This test can be used to visually determine appearance. The sample is placed in a clear glass jar and inspected for undissolved water, sediment, and suspended matter. For gasoline, the inspection is done at ambient temperature or 21°C (70°F), whichever is higher. Acceptable fuel is reported to be clear and bright and free of suspended material.</p>

# 4 • Oxygenated Gasoline

---

Oxygenated gasoline is not new; oxygenates have been added to gasoline for decades. Prior to 2006, methyl tertiary butyl ether (MTBE) and tertiary amyl methyl ether (TAME) along with smaller quantities of ethyl tertiary butyl ether (ETBE) were used in U.S. gasoline. Today, ethanol, also called *ethyl alcohol* or *grain alcohol*, is used almost exclusively.

Widespread use of ethanol in the United States began in 1978 when a Nebraska group marketed gasoline containing 10 volume percent ethanol as *gasohol*. The program was intended to help increase gasoline availability during the energy crisis of that decade. Later, the *gasohol* name was abandoned, but the use of ethanol continued. Much of the early ethanol-blended product was marketed in the Midwestern states, where the bulk of ethanol is produced.

In the 1990s, air quality regulations required gasolines in some parts of the United States to be oxygenated either in the winter or else year-round. (See page 27 for information regarding gasolines in carbon monoxide [CO] nonattainment areas and Federal Phase I and California Phase 2 reformulated gasolines [RFG].) By 2001, about 10 percent of all the gasoline sold in the U.S. contained ethanol and 58 percent of the blends contained 10 volume percent ethanol, often referred to as *E10*. Initially, little RFG contained ethanol.

As noted in Chapter 3, “Gasoline Refining and Testing,” MTBE was used as an oxygenate to meet U.S. Environmental Protection Agency (EPA) and California Air Resources Board (CARB) reformulation requirements. The first U.S. EPA waiver for MTBE use was issued in 1979 for 7.0 volume percent, and a second waiver for 15.0 volume percent was issued in 1988. MTBE was not widely used until the late 1980s, and then its use expanded with the introduction of federal RFG in 1995. California banned the use of MTBE and other ethers and heavy alcohols as of January 1, 2004. A number of other states followed California’s lead, which greatly diminished MTBE use. In 2006, the U.S. EPA rescinded the oxygenated gasoline requirement in federal RFG, as required by the Energy Policy Act of 2005. This resulted in the removal of virtually all MTBE from the U.S. gasoline pool. Gasoline refiners in the U.S. ceased using MTBE, and by default, ethanol became the oxygenate component used almost exclusively.

## CHEMISTRY

Oxygenated gasoline is a mixture of conventional hydrocarbon-based gasoline and one or more oxygenates. Oxygenates are combustible liquids made up of carbon, hydrogen, and oxygen. All the oxygenates currently used in gasoline belong to one of two classes of organic molecules: alcohols and ethers.<sup>1</sup> In alcohols, a hydrocarbon group and a hydrogen atom are bonded to an oxygen atom: R-O-H, where *R* represents the hydro-

<sup>1</sup> The word *ether* reminds many people of the anesthetic. Although the anesthetic commonly is called ether, its chemical name is diethyl ether (CH<sub>3</sub>CH<sub>2</sub>OCH<sub>2</sub>CH<sub>3</sub>). It is not used as a gasoline oxygenate because it is too volatile.

Table 4.1

## Oxygenates for Gasoline

Name	Formula	Structure	Oxygen Content Mass %	Blending Research Octane Number (BRON) <sup>1</sup>	Maximum Concentration Approved by EPA <sup>2</sup>	
					Mass % Oxygen	Volume % Oxygenate
Ethanol (EtOH)	C <sub>2</sub> H <sub>6</sub> O	CH <sub>3</sub> -CH <sub>2</sub> -OH	34.73	129	(3.70) <sup>3</sup>	10.0 <sup>4</sup>
Methyl Tertiary Butyl Ether (MTBE)	C <sub>5</sub> H <sub>12</sub> O	$\begin{array}{c} \text{CH}_3 \\   \\ \text{CH}_3-\text{O}-\text{C}-\text{CH}_3 \\   \\ \text{CH}_3 \end{array}$	18.15	118	(2.74)	15.0
Ethyl Tertiary Butyl Ether (ETBE)	C <sub>6</sub> H <sub>14</sub> O	$\begin{array}{c} \text{CH}_3 \\   \\ \text{CH}_3-\text{CH}_2-\text{O}-\text{C}-\text{CH}_3 \\   \\ \text{CH}_3 \end{array}$	15.66	119	2.70	(17.3)
Tertiary Amyl Methyl Ether (TAME)	C <sub>6</sub> H <sub>14</sub> O	$\begin{array}{c} \text{CH}_3 \\   \\ \text{CH}_3-\text{O}-\text{C}-\text{CH}_2-\text{CH}_3 \\   \\ \text{CH}_3 \end{array}$	15.66	119	2.70	(16.6)

<sup>1</sup> RON of the pure compound that is consistent with the RON of the oxygenate-gasoline mixture obtained by blending.

<sup>2</sup> Values in parentheses are approximations calculated from the regulated limit using the known specific gravity (relative density) of the oxygenate and a typical relative density of gasoline of 0.74.

<sup>3</sup> Assuming pure, undenatured ethanol. For denatured ethanol the value would be slightly lower.

<sup>4</sup> EPA limit is 10.0 vol % denatured ethanol. Denatured ethanol may have a purity of 92.0 vol % to 98.0 vol %.

carbon group. All alcohols contain the OH atom pair. In ethers, two hydrocarbon groups are bonded to an oxygen atom; the groups may be the same or different: R-O-R or R-O-R' (the apostrophe is used to indicate a different hydrocarbon group).

## USE

The U.S. EPA regulates which oxygenates and in what concentrations they can be added to gasoline in the U.S. through the Substantially Similar Rule and waivers (see sidebar on page 57). Table 4.1 summarizes such information. Note that, on a volume basis, each ether has a different maximum concentration because each has a different oxygen content and relative density.

Table 4.2 provides the ranges of oxygenate use – in terms of oxygen content of the gasoline – required by U.S. federal and California regulations. Any oxygenate use conforming with the U.S. EPA's Substantially Similar or waiver conditions is acceptable federally, but many states are in the process of banning or have banned the use of MTBE. Some states have banned the use of all ethers and heavy alcohols. The use of ethanol is encouraged by the U.S. Renewable Fuel Standard.

Usually, ethanol is blended with gasoline at terminals in the tank trucks that will deliver the blends to service stations. Terminal blending involves more operating and capital expense than refinery blending, but it avoids the product integrity concerns associated with bulk transport of gasoline-ethanol blends (discussed later). However, because ethanol can raise octane and volatility of blends, it typically needs to be blended with a lower-octane, reduced-volatility conventional gasoline to help ensure the final gasoline-ethanol blend meets finished fuel specifications and regulations. In the case of RFG, this base fuel is called reformulated blendstock for oxygenate blending, referred to as *RBOB*. In California, it is called *CARBOB*.

Table 4.2

Oxygen Content Required by U.S. Emissions Regulations

Regulation	Oxygen Content, Mass Percent	
	Minimum	Maximum <sup>1</sup>
<b>CO Nonattainment Areas<sup>2</sup></b> (4 or 5 winter months)		
California	1.8	2.2
Other States	2.7	3.7 <sup>3</sup>
<b>Federal RFG<sup>4,5</sup></b>		
Complex Model Phase II	0	4.0 <sup>6</sup>
<b>California Phase 3 RFG<sup>2</sup></b>		
Summer		
Flat Limit	1.8	2.2
Predictive Model	0	3.5 <sup>8</sup>
Winter		
Flat Limit	1.8	2.2
Predictive Model	1.8 <sup>7</sup>	3.5 <sup>8</sup>

<sup>1</sup> Regardless of this limit, specific oxygenates may not exceed their Substantially Similar or waiver limits. For example, the Substantially Similar maximum limit for ethers such as MTBE is 2.7 mass % oxygen (2.9 mass % in CO nonattainment areas in the winter).

<sup>2</sup> Per gallon limits.

<sup>3</sup> The maximum winter limit for Substantially Similar oxygenates is 2.9 mass % in CO nonattainment areas.

<sup>4</sup> Average limits.

<sup>5</sup> CO nonattainment area oxygen limits take precedence over RFG oxygen limits in CO nonattainment areas in the winter.

<sup>6</sup> Upper limit of valid range for oxygen content variable in model.

<sup>7</sup> The minimum limit only applies during specified winter months in specified CO nonattainment areas.

<sup>8</sup> If the gasoline contains more than 3.5 mass % oxygen but no more than 10 vol % ethanol, the maximum oxygen content cap is 3.7 mass % oxygen.

### **Methanol Is Not Ethanol**

*Ethanol and methanol should not be confused; they are different compounds. While gasoline oxygenated with methanol and its cosolvents has been available in limited amounts, its use is currently prohibited. Major differences between the two compounds include:*

- Gasoline oxygenated with methanol corrodes fuel system metals and accelerates deterioration of elastomers.
- Gasoline oxygenated with methanol is not approved for use by many vehicle manufacturers.
- Adding methanol to gasoline significantly increases the vapor pressure of the blend – an undesirable effect in this era of more stringent volatility controls.
- Methanol, unlike ethanol, is toxic.

Table 4.3

EN 228: Oxygenates Requirements

Oxygenate	Maximum Vol %
Methanol	3
Ethanol	5
Isopropyl Alcohol	10
Isobutyl Alcohol	10
Tert-Butyl Alcohol	7
Ether (5 or more C atoms)	15
Other Oxygenates	10

As long as U.S. EPA concentration limits are observed, oxygenates may be used in areas of the U.S. where adding oxygenates is not required to meet wintertime CO nonattainment requirements. This is allowed when the octane of the gasoline needs enhancement and when adding oxygenates is more cost-effective than other methods. Further, renewable oxygenates must be used to comply with the U.S. Renewable Fuels Standard and EU Biofuels Directive.

The information available to retail consumers about the oxygenate composition of gasoline varies. Labeling is controlled by state, not federal, regulations. Some states require dispenser labels for oxygenated gasolines in wintertime CO nonattainment areas and for RFG. A typical label reads: *The gasoline dispensed from this pump is oxygenated and will reduce carbon monoxide pollution from motor vehicles.* Such labels do not provide any information about which oxygenate(s) the blend contains; others do. The National Conference on Weights and Measures (NCWM), an association of state weights-and-measures agencies responsible for dispenser calibration and labeling, issued a revised standard guideline for dispenser labeling in 1996. Some states follow the NCWM guidelines, some follow modified versions, and others have their own requirements.

In Europe, the EN 228 specification limits the maximum amounts of various oxygenates in gasoline (see Table 4.3). The European Union has set targets for each member state for the market share of biofuels. These targets are based on the challenging benchmarks set by Directive 2003/30/EC: 2 percent market share by December 2005 and 5.75 percent market share by December 2010.

In Japan, JIS K 2202 allows MTBE only up to 7 volume percent. Canada limits methanol to 0.3 volume percent, other oxygenates to 2.7 mass percent oxygen, and ethanol specifically to 10 volume percent maximum. In Brazil, Agência Nacional do Petróleo (ANP) Regulation No. 309 stipulates that only Type C gasoline may be sold. The ethanol content and specifications are set by separate legislation, and the current required ethanol content is 25 volume percent (plus or minus 1 percent). Conventional vehicles in Brazil are calibrated to use this high level.

## SOURCES

Ethanol can be synthesized from petroleum by hydrating ethylene, but most of it (94 percent of the worldwide supply in 1993) is derived from the fermentation of carbohydrates, principally corn in the United States. Sugar cane is used in many parts of the world. The process involves distillation to separate ethanol from fermentation residues, dehydration to remove the water that co-distills with the alcohol, and, for fuel ethanol, addition of a noxious or toxic material (denaturing) to make it unfit for human consumption.

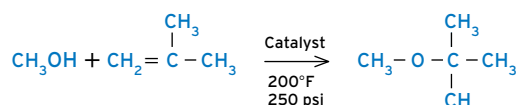



MTBE is derived from methanol and isobutylene. A catalyst is used to assist the reaction. Most methanol is produced from natural gas (methane). Isobutylene is obtained from petroleum, either as a byproduct of the refining process or from butane. Although it is made from methanol, MTBE is a different material with different properties. For instance, MTBE doesn't have methanol's corrosivity and toxicity defects (see sidebar on page 55). The other ethers are made by similar processes. ETBE is derived from ethanol and isobutylene. TAME is derived from methanol and isoamylenes.

## SPECIFICATIONS

ASTM D4806 *Standard Specification for Denatured Fuel Ethanol for Blending with Gasolines for Use as Automotive Spark-Ignition Engine Fuel* is used to specify product quality for ethanol in the United States. CARB specifies D4806 with additional content limits on sulfur, aromatics, benzene, and olefins for California Phase 3 RFG. D4806 limits denaturants to hydrocarbons boiling in the gasoline range because of harmful side effect concerns for other materials.

ASTM D5983 *Standard Specification for Methyl Tertiary-Butyl Ether (MTBE) for Downstream Blending for Use in Automotive Spark-Ignition Engine Fuel* is used for merchant MTBE in the United States.

## PERFORMANCE ISSUES

**Fuel Leaning** Oxygenated gasoline leans the air-fuel mixture of carbureted engines and fuel-injected engines that have older open-loop fuel systems. If an open-loop fuel system is set to provide a very fuel-rich mixture, fuel leaning might help improve performance. Otherwise, fuel leaning can degrade driveability; the extent depends on an engine's calibration.

Newer engines have closed-loop air-fuel ratio control incorporating an electronic control module (ECM, see page 69) that adjusts air-fuel ratio to compensate for oxygen in fuel. However, an ECM may default to preset open-loop calibrations when an engine is cold and its oxygen sensor is not at operating temperature, when power demand is high (such as during rapid acceleration), or when the exhaust oxygen sensor is defective. Under such conditions, oxygenated gasoline leans the air-fuel mixture in newer engines like it does in older open-loop fuel systems. Vehicles with adaptive learning can compensate for changes in stoichiometric air-fuel ratio.

Ethanol has a higher heat of vaporization than ethers. Some of the degradation in driveability experienced with gasoline oxygenated with ethanol can be attributed to the additional heat needed to vaporize the fuel.

**Volatility** Adding ethanol to a conventional gasoline not designed for alcohol blending can produce a blend that exceeds RFG vapor pressure limits. In conventional gasoline that has a vapor pressure of 62 kPa (9.0 psi), ethanol can raise vapor pressure 6.9 kPa (1.0 psi);

### **U.S. Oxygenate Regulation and the Substantially Similar Rule**

*The Clean Air Act Amendments of 1977 control the use of oxygenates in unleaded gasoline. The purpose of the amendments is to ensure that oxygenate use won't contribute to emission control system failures that could result in increased emissions. The regulations that the U.S. EPA developed to implement the law prohibit the introduction or increase in concentration of a fuel or fuel additive that is not substantially similar to any fuel or fuel additive used in the certification of any 1975 or subsequent model-year vehicle.*

*In 1981, the U.S. EPA issued the Substantially Similar Rule, recognizing that the use of certain types of oxygenates was safe below a specified oxygen content. The rule, as revised in 1991, allows aliphatic alcohols (excluding methanol) and/or aliphatic ethers to be blended into gasoline up to a concentration that would result in 2.7 mass percent oxygen in the blend. The rule requires the finished blend to possess all the physical and chemical characteristics of an unleaded gasoline specified by ASTM D4814-88 for at least one of the seasonal and geographic volatility classes.*

*U.S. EPA regulations also created a process by which a waiver could be granted for an oxygenate recipe that an applicant has demonstrated will not cause or contribute to the failure of any emission control device or system. The U.S. EPA has granted waivers for concentrations of ethanol in gasoline up to 10 volume percent. (The mass percent*

*(continued on next page)*

---

*(continued from previous page)*

*oxygen content of this blend depends on the density of the gasoline. For gasoline with the typical relative density of 0.74 at 15.6°C [60°F] blended with 10 volume percent pure ethanol, the resulting oxygen content is 3.7 mass percent. For the same gasoline blended with 10 volume percent denatured ethanol, the resulting oxygen content is 3.5 mass percent. The U.S. EPA also has ruled that gasolines containing up to 2.0 volume percent MTBE (not purposely added) that are subsequently blended with 10 volume percent ethanol (resulting in a total oxygen content of 4.0 mass percent if blended with pure ethanol) do not violate the ethanol waiver. This ruling was made to assure an adequate supply of base gasoline for blending with ethanol.*

*The U.S. EPA also has granted waivers for blends of gasoline and gasoline-grade tertiary butyl alcohol (TBA) up to 3.5 mass percent oxygen content (16 volume percent TBA) and for various blends of methanol and gasoline-grade TBA or other higher-molecular-weight alcohols (cosolvents).*

*Further, any fuel or fuel additive registered with the U.S. EPA must have a supplemental registration involving toxicity that may require additional toxicity testing. None of the methanol-containing waivers has a supplemental registration. Oxygenates that were not initially registered now will require full toxics studies to be completed before they can be used.*

in RBOB that has a vapor pressure of 39.6 kPa (5.7 psi), ethanol can raise vapor pressure 9.0 kPa (1.3 psi). This increase, coupled with the corresponding reduction in mid-range distillation properties, lowers the V/L = 20 temperature, reducing vapor lock protection. Blend volatility is increased only slightly by MTBE and not at all by ETBE and TAME.

Because it significantly increases fuel volatility, ethanol has not been the oxygenate of choice for summer RFGs, which have very tight vapor pressure limits. Now, with increasing use of ethanol, hydrocarbons with higher volatility must be removed during the production of RBOB to help ensure the final gasoline-ethanol blend meets specifications and complies with regulations.

*Commingleing*, another volatility issue, can occur if ethanol-blended fuel is mixed with hydrocarbon-only fuel in a vehicle fuel tank. In effect, the ethanol in the ethanol blend increases the vapor pressure of the hydrocarbon-only gasoline. The increase in vapor pressure is dependent on the ratio of the two components and the amount of ethanol in the blend. The maximum effect of about 6.2 kPa (0.9 psi) increase occurs for a 5.7 volume percent ethanol blend when the mixture contains about 75 percent hydrocarbon-only gasoline where both fuels initially have a vapor pressure of 48.3 kPa (7.0 psi).

**Water Tolerance** Conventional gasoline, depending on its aromatics content, can dissolve up to 150 parts per million (ppm) water at 21°C (70°F). Oxygenating gasoline with ethers can increase water solubility to 600 ppm. Contacting either conventional gasoline or ether-oxygenated gasoline with additional water will not affect the properties of the gasoline but can make it appear hazy.

Water-saturated blends become hazy when cooled because some of the water becomes insoluble. However, the water that is released does not contain much ether, and the blends do not contain enough water to cause performance problems.

The situation is different for gasoline oxygenated with 10 volume percent ethanol. The gasoline-alcohol blend can dissolve more water (6,000 ppm to 7,000 ppm at 21°C/70°F). When this blend is cooled, both the water and some of the ethanol become insoluble. Contacting the blend with more water also draws ethanol from the blend. The result, in both cases, is two layers of liquid: an upper ethanol-deficient gasoline layer and a lower ethanol-rich water layer. Depending on how much water is present, up to 90 volume percent of the ethanol in the gasoline phase can be extracted into the water phase. This process, called *phase separation*, occurs because ethanol is completely soluble in water but only marginally soluble in hydrocarbons. After phase separation, the gasoline layer will have a lower octane number and may cause knocking. The fuel also is less volatile. An engine will not run on the water-ethanol layer. As the concentration of ethanol is decreased, or as the aromatics content of the gasoline is decreased, or as temperature is decreased, less water is required to cause a phase separation.

Because of the potential for phase separation, gasoline-ethanol blends should not be exposed to water during distribution or use in a vehicle. Consequently, gasoline-ethanol blends are not transported in pipelines, where water may accumulate in low spots. Rather, ethanol is added to tanker trucks at a terminal immediately before delivery to service stations. Good housekeeping at a service station is also very important to help prevent water contamination. This sensitivity to water also means that extra care should be taken when gasoline-ethanol blends are used as a fuel for boat engines. Gasoline-ethanol blends are hygroscopic (absorb moisture from the air). During long-term storage, gasoline-ethanol blends can phase-separate if a storage tank is vented to the atmosphere and subject to breathing as a result of temperature changes.

**Material Compatibility** Some fuel system metal components will rust or corrode in the presence of water or acidic compounds. The additional water dissolved in oxygenated gasolines does not cause rusting or corrosion, but water resulting from phase separation of gasoline-ethanol blends will, given time.

Oxygenates can swell and soften natural and some synthetic rubbers (elastomers). Oxygenated gasolines affect elastomers less than oxygenates do, the extent of which depends on the type of elastomer and on the hydrocarbon chemistry of the gasoline, particularly its aromatics content. The effect is of potential concern because fuel systems contain several types of elastomers in hoses, connectors (O-rings), valves, and diaphragms. The elastomeric materials used in today's vehicles in the U.S. have been selected to be compatible with oxygenated gasolines. In their owner's manuals, vehicle and equipment manufacturers typically indicate whether the use of oxygenated gasolines is acceptable. Manufacturers approve the use of gasoline oxygenated with up to 10 volume percent ethanol or 15 volume percent MTBE. (The compatibility of other ethers is the same as that of MTBE.) The approved levels may be higher or lower outside the United States.

Automobile and equipment manufacturers upgraded their fuel system elastomers at different times. Elastomers in U.S. vehicles manufactured before 1975 may be sensitive to oxygenated and high-aromatics gasolines. In U.S. vehicles manufactured between 1975 and 1980, elastomers were upgraded but not to the same extent as later models.<sup>2</sup> Elastomer compatibility in other parts of the world may not be the same as in the United States.

Recent claims contend that certain older fiberglass fuel tanks contain resins that are incompatible with ethanol. Such tanks had been used at one time for bulk gasoline storage, and they may be found in certain older boats. Owners of older boats or boats that include older fuel storage systems should consult the manufacturer to determine compatibility.

<sup>2</sup> Reynolds, Robert E., et al., *Changes in Gasoline III*, Downstream Alternatives, Inc., Bremen, Ind., 1996.

---

Chevron has not observed a significant compatibility problem between oxygenated gasolines and elastomers in older U.S. cars. There was not an increase in problems when oxygenated gasoline was introduced in 39 metropolitan areas in the winter of 1992. This held true for the Western states, which tended to have a higher number of older cars in their vehicle populations, and for areas where different oxygenates were used (MTBE, and now ethanol throughout California and in Portland, Oregon, and Seattle/Tacoma, Washington).

**Fuel Economy** The effect of oxygenated gasoline on fuel economy is discussed on page 9.

**Permeability** Gasoline components diffuse through elastomeric hoses and seals and through plastic fuel tank surfaces and contribute to evaporative emissions. Compared to non-ethanol gasolines, gasolines that contain ethanol worsen the problem in two ways: not only does ethanol permeate non-metal fuel system components, but a larger amount of gasoline hydrocarbons do, too. Studies conducted by the Coordinating Research Council<sup>3</sup> show that permeation emissions through vehicle fuel system elastomers increase on average by about 65 percent for a typical California Phase 3 gasoline oxygenated with 5.7 volume percent ethanol compared to a typical California Phase 2 gasoline oxygenated with 11 volume percent MTBE or to a non-oxygenated Phase 3 gasoline.

<sup>3</sup> *Fuel Permeation from Automotive Systems*, No. E-65, Coordinating Research Council, Alpharetta, Ga., September 2004; and *Fuel Permeation from Automotive Systems: E0, E6, E10, E20 and E85*, No. E-65-3, Coordinating Research Council, Alpharetta, Ga., December 2006.

# 5 • Gasoline Engines and Selected Systems

Understanding the performance of a gasoline-powered vehicle requires knowledge not only about gasoline but also, to some extent, knowledge about the vehicle's engine and the engine's related systems.<sup>1</sup> Two types of engine technology are described in this chapter: conventional technology and developing or advanced technology.

The mainstay of most vehicles on the road today, conventional engine technology is a function of combustion, engine structure, and a set of interconnected systems. Four major systems of a gasoline-powered engine will be covered here:

- Air
- Exhaust
- Fuel
- Engine/emission control

The *air system* delivers a mixture of air and fuel to the engine. The *fuel system* provides for gasoline storage in the vehicle, delivers gasoline to the air intake system, and mixes air and gasoline in the correct proportion for burning in the engine. The *exhaust system* routes combustion gases to the atmosphere. In modern vehicles, a complex computerized *control system* balances the often conflicting goals of high power, good fuel economy, and low emissions.

An effort is underway to improve ambient air quality by reducing vehicle exhaust emissions, to conserve natural resources, and to lower greenhouse gas emissions. Several new technologies to enhance the performance of the conventional engine are being developed and are starting to appear on new vehicles. In addition, advanced technologies such as gasoline-electric hybrid and fuel cell powertrains are in various stages of development as alternatives to conventional engines.

## CONVENTIONAL ENGINE TECHNOLOGY

### Combustion Cycle

A gasoline-powered automotive engine is an internal combustion, spark-ignition engine that burns fuel in enclosed chambers called *cylinders*. (A diesel-powered engine also is an internal combustion engine with cylinders, but it doesn't involve spark ignition; fuel ignites spontaneously at the higher pressures and temperatures at which the engine operates.) Engine power is generated by the rapid expansion of gases during combustion of a compressed air-fuel mixture. Most automotive engines are reciprocating piston-type devices in which multiple cylinders each house a *piston* that slides back and forth. Power from the motion of one or more pistons is transmitted through a connecting rod to a crankshaft, which is coupled to the drive wheels by a drivetrain.

Most automotive gasoline engines operate in a *four-stroke cycle*. Each stroke is one motion of a piston, either up or down. Figure 5.1 illustrates the four-stroke cycle. The first downward motion of a piston, called the *intake stroke*, draws a mixture of air and fuel into a

### Engine Terms and Abbreviations

A piston that is at the top of its travel path, or stroke, relative to the cylinder head, is at top dead center (TDC). Conversely, a piston that is at the bottom of its stroke is at bottom dead center (BDC). Four strokes occur over two complete revolutions (720°) of crankshaft rotation. Valves are used to control gas flow into or out of a combustion chamber, the volume above a piston in a cylinder. The compression ratio of a cylinder is the ratio between the volume in the combustion chamber when a piston is at BDC and the volume when a piston is at TDC. The swept volume of a cylinder is the region above a piston at BDC but below a piston top when it is at TDC. An engine's displacement is the total swept volume of all its cylinders.

<sup>1</sup> Some of the information in this chapter was drawn from the vehicle references listed in "Sources of More Information" (see page 95).

Figure 5.1

### The Four Strokes of a Gasoline Internal Combustion Engine

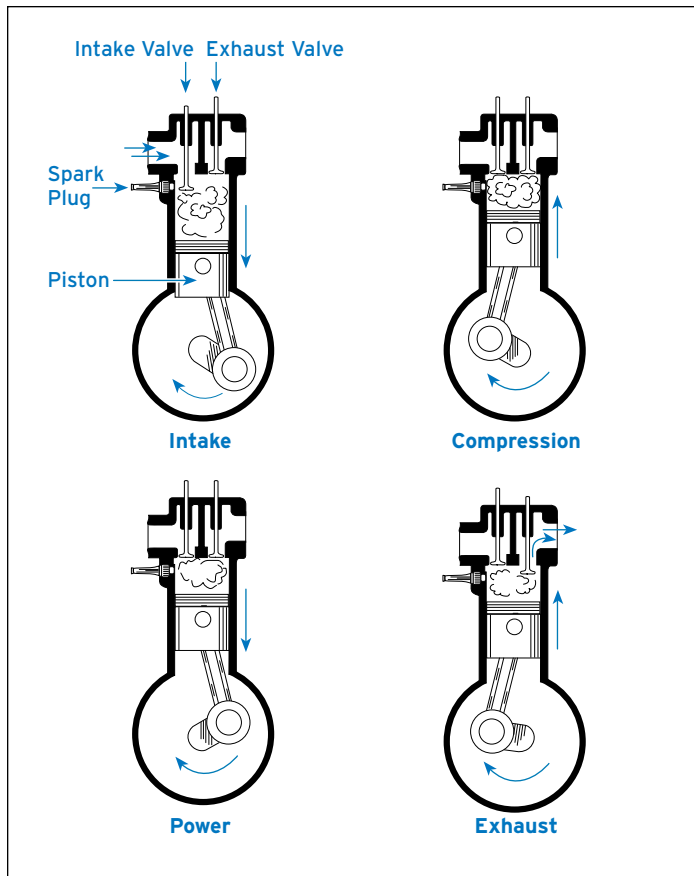

combustion chamber through open intake valves. As the piston reverses direction and begins to move back up, the intake valves close. This upward motion of the piston is the *compression stroke*. Compression raises the pressure and temperature of the air-fuel mixture. Near the top of the compression stroke, a spark plug produces a spark, igniting the mixture. The mixture burns and expands, which drives the piston downward in its third movement, or *power stroke*. As the piston passes *bottom dead center* (BDC, see sidebar on previous page) and begins to move back up again, exhaust valves open, beginning the *exhaust stroke*. The upward motion of the piston pushes burned gases out of the engine into an exhaust manifold and eventually out an exhaust pipe.

For combustion to occur in a cylinder, fuel must be in the vapor state (see page 1), and to burn completely, fuel must have the right mix of air and fuel vapor. The ideal combination, called the *stoichiometric mixture*, in non-oxygenated gasoline is a ratio of 14.7:1 of air mass to fuel mass. A mixture with less air and more fuel is *fuel-rich*, and a ratio with more air and less fuel is *fuel-lean*.

Control of the air-fuel ratio (A/F) is critical to good emissions performance in an engine. Because emission of carbon monoxide (CO) and volatile organic compounds (VOCs) increases under fuel-rich operation and emission of nitrogen oxides (NO<sub>x</sub>) rises during fuel-lean operation (see Chapter 2, “Gasoline and Air

Quality”), most modern vehicles are built to maintain stoichiometric A/F. The section on control systems later in this chapter describes how this is accomplished.

### Engine Structure

An engine is generally separated into two distinct sections, a cylinder head and a block (Figure 5.2). The *head*, or top, controls gas flow through the engine and also holds spark plugs. Poppet *intake valves* and *exhaust valves* allow for precisely timed intake and exhaust flows. (Spring-closed poppet valves can be opened and closed very quickly, an essential feature for optimum performance at high engine speeds.) Valve movement is controlled by means of a *camshaft*, a rod with elliptical lobes (cams) protruding from it. As the camshaft rotates, the lobes push against rocker arms to open the valves against spring pressure either directly or by means of pushrods.

## Gasoline Engines and Selected Systems

An engine with *overhead cam* (OHC) has a camshaft mounted in the head above the valves. A *pushrod* engine has a camshaft mounted below the valves, on the block. Pushrods transmit valve-opening force from tappets, which ride on the camshaft lobes, up to the rocker arms. In an engine that has *dual overhead cam* (DOHC), each cylinder head has two camshafts overhead. An overhead camshaft is driven off the crankshaft by either a timing belt or a timing chain; a block-mounted camshaft is driven by either a timing chain or a gear.

Engines typically have one to three intake valves and one or two exhaust valves per cylinder (Figure 5.3). An engine with two intake and two exhaust valves per cylinder has a *four-valve head design*. More valves per cylinder are preferred for better breathing. Usually, an engine's exhaust valves are slightly smaller in diameter than its intake valves. Pushing out exhaust gases pressurized above atmospheric pressure is easier than drawing in air-fuel mixture at atmospheric pressure. Valve seats are hardened to withstand the high temperatures of combustion gases and to prevent abrasion that could result from valve contact and rotation.

The *block*, or bottom of an engine, contains the power-producing mechanical components. Cylinders in the block contain pistons. Typically each piston has at least three rings mounted in grooves around its perimeter to seal off the combustion chamber above. Each piston is supported by a *wrist pin* that is attached to a *connecting rod*. All of the connecting rods are attached to the engine's *crankshaft*. As the air-fuel mixture ignites and expands in a combustion chamber, it forces the piston down, which moves the connecting rod and turns the crankshaft. The crankshaft is mounted at the bottom of the engine in a volume called the *crankcase*. An oil pan forms the bottom of the crankcase. From here, an oil pump distributes oil throughout the engine, including the head's *valve train* (the valves and the camshaft, which opens and closes the valves).

Passenger car engines may have as few as three cylinders or as many as 12. Engines that have fewer than six cylinders are often designed in an *in-line* configuration, their cylinders arranged upright and in a row. A common design for engines that have six or more cylinders is the V configuration; in *V engines* such as the V-6 and V-8, two facing rows, or banks, of cylinders slant toward each other along a base where a crankshaft resides. Far less common among four-cylinder and six-cylinder passenger cars is the flat engine design. Like the V configuration, this design has opposing cylinder banks separated by a crankshaft, but the banks lay flat, not at a slant.

Figure 5.2

**Cutaway of a Four-Cylinder Overhead-Cam Gasoline Internal Combustion Engine**

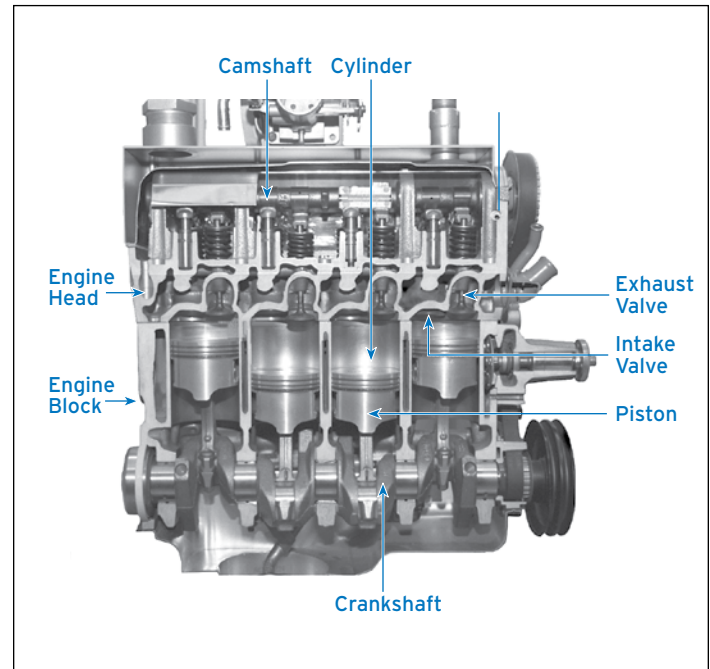
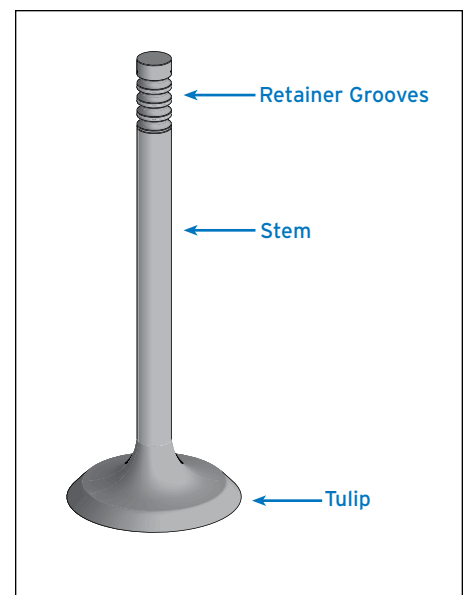

Figure 5.3

**Poppet Valve**





---

Engine design is one way to reduce emissions. Identifying how pollutants are created can lead to changes that minimize them at the source. For example, exhaust VOC emissions can be reduced by careful mechanical design of combustion chambers and air intake and fuel systems.

## Air System

An *air intake system*<sup>2</sup> draws air into an engine and regulates engine power. Suction created by piston movement pulls air through a duct to an *air filter* that captures abrasives and contaminants such as dust and insects. Air continues past the filter to be mixed with fuel. Air flow is controlled by a throttle mounted on a spindle in the duct leading out of the air filter. The *throttle* is simply a rotating disk that, in normal position, blocks air flow to the engine. It is connected to an *accelerator pedal*, which a driver depresses to tilt the disk and release air to the engine. With more air, the engine can use more fuel and produce more power to accelerate, climb a hill, or maintain speed.

### Intake Air Pressurizing

An engine that uses intake air at atmospheric pressure is said to be *naturally aspirated*. The amount of air a naturally aspirated engine can use is limited by the local air density (barometric pressure) and pressure losses in the engine air intake system. To draw more air into an engine, small compressors sometimes are used to pressurize intake air. If a compressor is driven off an engine crankshaft, it is called a *supercharger*. Superchargers usually are belt-driven, either directly or through a clutch. Positive displacement superchargers generally are used on small- and medium-displacement engines in which the balance between supercharger size and increase in engine power is acceptable. Another way to power a compressor is to put it on a common shaft with a turbine driven by engine exhaust. This arrangement is called *turbocharging*. Turbochargers are more compact than superchargers and can be used on all sizes of engines. To maintain boost pressure over a wide range of engine speeds, some sort of pressure regulator is needed. A *wastegate* is the typical solution. The wastegate opens to divert some of the exhaust flow around the turbine when boost pressure is at the desired level.

### Positive Crankcase Ventilation

Positive crankcase ventilation (PCV) was one of the first techniques employed to reduce unburned VOC emissions from gasoline-powered vehicles. Required initially on California vehicles in 1961, it involves recycling an engine's unused combustion gases. During combustion, high pressure in the combustion chambers forces a small fraction of gas between the piston rings and cylinder walls. These *blow-by gases*, a mixture of unburned fuel, air, and combustion products, end up in the crankcase. Left to accumulate, they would create enough pressure in the crankcase to force oil out of the engine. To avoid this, the gases vent through tubing and a flow control valve into the engine's air intake system.

<sup>2</sup> Also known as *air intake manifold*. The system is a passageway of tubing through which air flows and is distributed.

From there, the gases are drawn into the cylinders and burned. Prior to the use of PCV, blow-by gases were vented to the atmosphere and were a significant source of VOC emissions.

## Fuel System

### Carburetors

In the intake system of an engine, air is mixed with a small amount of vaporized gasoline to produce a homogeneous air-fuel mixture. Many different devices have been used to perform the mixing, the carburetor being the most common (Figure 5.4) in older engines. A carburetor employs a venturi to discharge the correct amount of fuel into the intake airstream. A *venturi* is a converging-diverging nozzle, essentially a tube that tapers inward from both ends to a narrow section or throat.

As air passes through the venturi, its velocity increases as it nears the *throat* because the flow area decreases. As the air speeds up, its pressure decreases, creating a vacuum that draws fuel out of the carburetor's fuel bowl through a tiny orifice called a *jet*. Additional jets are used to enrich the mixture during acceleration and to supply sufficient fuel at idle. A *choke plate* or valve is used to enrich the mixture when the engine is cold by reducing the amount of air available to the engine. The choke is above the venturi and the throttle is below the venturi on *downdraft carburetors*, the most common type of carburetor in use today. *Sidedraft carburetors* are used in motorcycles and sports cars, while *updraft carburetors* are found in older engines.

Modern carburetors usually have two venturis, often referred to as barrels. A *two-barrel carburetor* on an in-line engine has two sets of staged venturis. The primary venturi is used for moderate driving and helps keep fuel consumption at a minimum. The second venturi provides greater air and fuel flow for more power. Larger, more powerful V engines require *four-barrel carburetors* in which one set of venturis is usually larger than the other. The smaller set is used alone at low loads; both sets are used for high loads.

Carburetors have been replaced by fuel injectors on new vehicles because carburetors do not control fuel flow precisely enough to meet exhaust emission requirements. In part this is because they are volume flow-based and are difficult to calibrate optimally for all operating conditions.

Figure 5.4

Intake System of a Gasoline Internal Combustion Engine With a Two-Barrel Carburetor

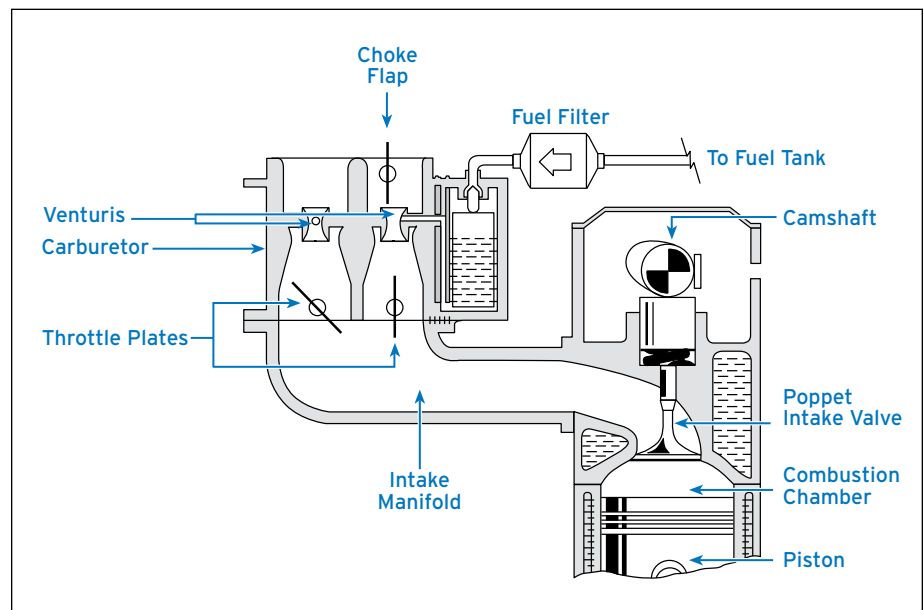

Reprinted with permission from Robert Bosch Corporation.

## Injectors

To overcome the carburetor's limitations, engine builders switched to *fuel injectors* to meter the amount of fuel delivered to the inlet air. These fuel injection systems can be categorized into three broad groups depending on where the injectors are installed:

- *Throttle body injection (TBI)*, in which the injector resides in the throttle body, mounted on the air intake manifold.
- *Port fuel injection (PFI)*, which uses one injector that sprays fuel on the intake valves at the intake port of each cylinder (Figure 5.5). To enrich the mixture during cold starts, an additional cold-start injector may be built in. This injector sends additional fuel to the intake air for a short period while the engine warms up.
- *Central port fuel injection (CPFI)*, which uses a central distribution valve connected by tubes that run down each inlet manifold to spring-loaded poppet nozzles that spray fuel on the intake valves.

An electrically powered *fuel pump* provides fuel at low pressure (205–345 kPa/30–50 psi) to either the central injection units or the individual port injectors. *Returnless* fuel systems use higher pressure (480–525 kPa/70–76 psi). Future electronic returnless fuel systems will be running at even higher maximum pressures (600 kPa/87 psi). A *fuel filter* is installed in the line after the pump to remove particulate matter from the fuel and help prevent the injectors from clogging. Often another filter is used in the port fuel injector itself to catch any particles that may have escaped the main filter. A diaphragm *pressure regulator* maintains pressure and routes excess fuel back to the fuel tank. In returnless port injector systems,

Figure 5.5

### Fuel and Control Systems of a Gasoline Internal Combustion Engine With Port Fuel Injection

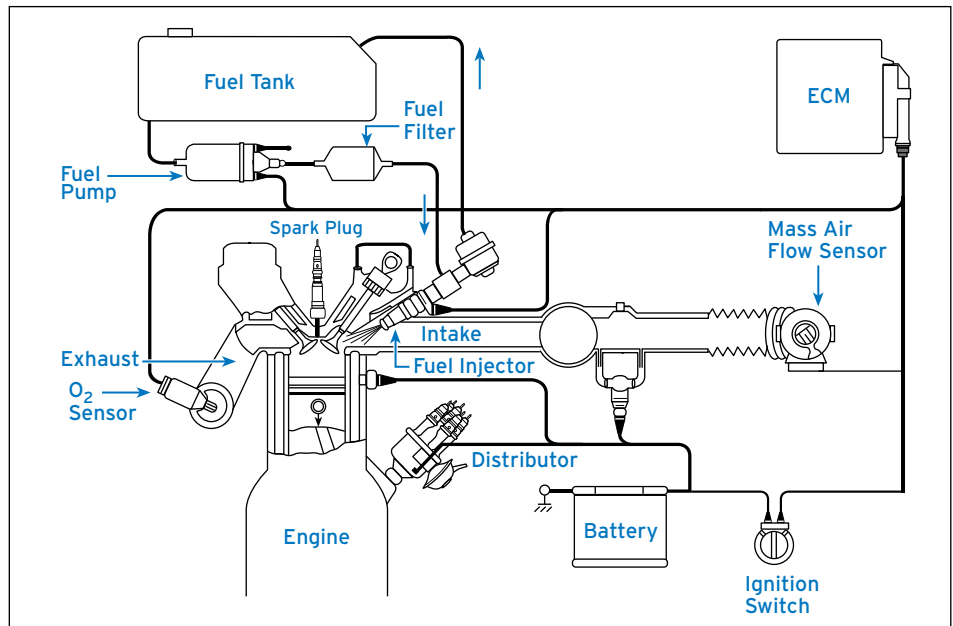

Reprinted with permission from Robert Bosch Corporation.

fuel is not returned to the tank but remains in the distribution rail when the injectors are closed. This is done to minimize evaporative hot soak and running losses but increases the chance for hot fuel handling and vapor lock problems.

A port fuel injector is illustrated in Figure 5.6. When the injector is off, the spring keeps the needle against the seat, preventing fuel flow. Energizing the solenoid winding pulls the needle back against spring pressure (it moves only about 0.15 mm/0.006 in), allowing fuel to flow through the annular passage, around the needle and out through the injector tip. The needle tip, or *pintle*, is designed to break up the liquid fuel into a fine spray to promote rapid formation of vapor and enhance the mixing of fuel and air. Another type of port injector that is widely used substitutes a *director plate* – a flat plate with several tiny holes – for the pintle.

Several strategies are used to time fuel injection. Some older TBI and PFI systems inject fuel almost continuously, much like a carburetor. Intermittent injection systems fire injectors simultaneously to deliver the same quantity of fuel to each cylinder. These systems sometimes deliver fuel twice per cycle. Sequential injection systems fire injectors sequentially at the same crankshaft angle on each cycle. Fuel quantity is metered by controlling the time an injector is open (*pulse width*).

### Storage

Vehicle fuel tanks are typically sized to provide a range of travel between 450 km and 650 km (275 miles and 400 miles). Until the latter 20th century, most fuel tanks were made of steel, which corrodes rapidly in combination with water and organic acids from gasoline. As protection, steel tanks are now lined with corrosion-resistant material, commonly a plating of a tin-lead (*terneplate*) or zinc-nickel alloy. Organic coatings also have been used. Mercedes introduced an all-aluminum tank in 1991, and Volkswagen pioneered the use of a plastic fuel tank in 1976. Plastic tanks can be formed in complex shapes to increase fuel storage capacity and are used on a large percentage of today's vehicles. A significant problem with plastic tanks is that fuel vapor can permeate their walls. High-density polyethylene tanks must be lined with low-permeability material, or the vehicles in which they're mounted will have evaporative emissions that exceed regulatory limits (see pages 20 and 60).

Figure 5.6

Section View of a Port Fuel Injector for a Gasoline Internal Combustion Engine

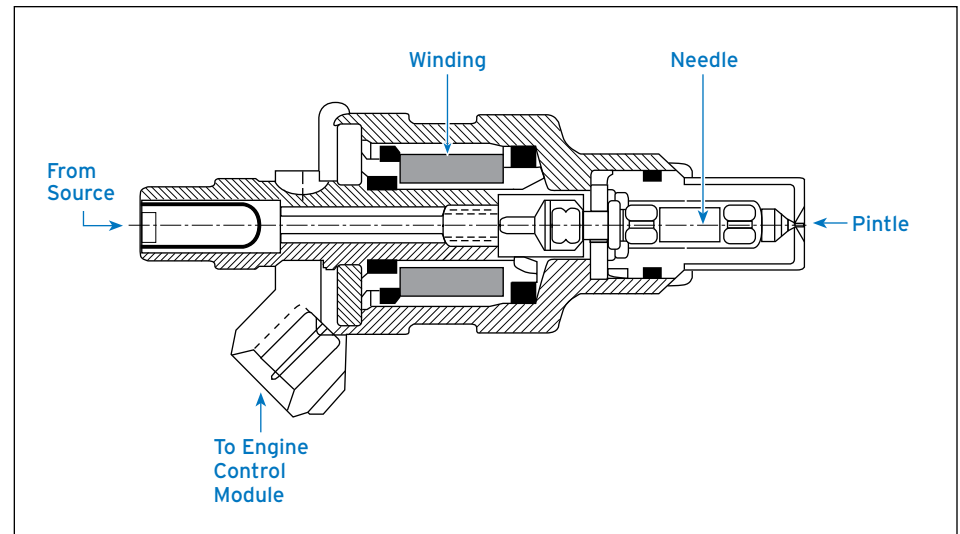

Reprinted with permission from Robert Bosch Corporation.

---

### **Catalytic Converters and Unleaded Gasoline**

*Unleaded gasoline is critical to the function of catalytic converters. In vehicles equipped with catalytic converters, leaded gasoline will quickly terminate catalytic activity altogether. Metals in the catalyst adsorb lead from engine exhaust, which creates a barrier that inhibits the catalyst from treating emissions.*

*Evaporative emissions control systems* have been employed on all gasoline passenger cars sold in California since 1970 and throughout the United States since 1971. These systems collect vapor resulting from the evaporation of gasoline in the fuel tank and introduce it into the engine later. The heart of the system is a canister containing activated carbon. It is positioned in the line through which the tank *breathes*, drawing in air from the atmosphere as gasoline is consumed or when the tank temperature drops and emitting air when the tank temperature rises. The activated carbon absorbs gasoline vapor in the emitted air like a sponge absorbs water, preventing the vapor from reaching the atmosphere. The canister also is connected to the engine's air intake system by the *purge control valve*, which is opened at certain times to allow the accumulated vapors to be purged from the canister and burned in the engine. For the system to work, the canister must be the tank's only vent to the atmosphere. The filler tube must be sealed by a functional, properly tightened gas cap.

Other sources of fuel-related emissions, such as those resulting from fuel leaks, seepage, or permeation through hoses and tanks, can be controlled through design, raw material choices, and prompt repair.

### **Exhaust System**

Combustion gases are routed out of the engine by the exhaust system, which has four parts: exhaust manifold, exhaust pipe, catalytic converter, and muffler. The *exhaust manifold* collects exhaust gases from several cylinders and combines them into one flow stream. The exhaust pipe runs from the exhaust manifold underneath the vehicle to the rear. The *catalytic converter* and the *muffler*, which reduces engine noise, are mounted in the exhaust pipe.

### **Catalytic Converter**

A catalytic converter may be the most important emission control device on a vehicle. Simply a canister positioned between the engine and exhaust pipe, it holds catalysts that convert pollutants into nonpolluting compounds as they pass through the exhaust system to the atmosphere. The catalysts contain precious metals such as platinum, palladium, and rhodium. *Close-coupled* catalytic converters are positioned near the engine. *Underfloor* catalytic converters sit under the floor of a vehicle next to or as part of its muffler.

The first catalysts were oxidation catalysts. As the name indicates, they were used to oxidize CO and VOCs into carbon dioxide and water. To work properly, the catalyst required excess oxygen in the exhaust, made available either by operating the engine with a fuel-lean mixture or by injecting air directly into the exhaust stream between the engine and the catalyst.

Converters have been installed on gasoline-powered vehicles since 1975 in the U.S, and *three-way catalytic converters*, introduced around 1980, are now used almost exclusively.

They perform the oxidation function just described and also reduce  $\text{NO}_x$  into nitrogen and oxygen. Excess oxygen interferes with the  $\text{NO}_x$  reduction reaction, so the three-way catalytic converter performs best when A/F is very near stoichiometric value. Thus, careful control of A/F is doubly important on modern cars: first, to minimize the formation of CO and VOCs in the engine, and second, to maximize efficiency of the three-way catalytic converter.

To meet ever more stringent exhaust emission requirements, an engine may be designed with additional converters mounted at the exit of the exhaust manifold before the under-floor converter. Other designs involve a single converter placed closer to the exhaust manifold. Such designs allow converters to light off (that is, reach the heat necessary to begin functioning) more quickly and thereby reduce emissions sooner after ignition. Some systems also use insulated exhaust pipes to assure faster warm-up of the converters.

Most converters today consist of a monolithic (honeycomb-style) substrate that has parallel channels coated with catalytically active material. Brick-like in form, the substrate may have a cell density at or below 400 cells (or channels) per square inch. To meet stricter emission limits in the future, cell densities are likely to reach as high as 1,200 cells per square inch. With slimmer, more numerous channels, the substrate will have more active surface area to treat exhaust but will also be more prone to plugging by exhaust particles.

### Exhaust Gas Recirculation

Exhaust gas recirculation (EGR) is a strategy employed in many modern gasoline engines to reduce  $\text{NO}_x$  emissions. The principle is relatively simple: Exhaust gas is essentially inert since it has already been burned. If some of this exhaust gas is introduced into the intake manifold (recirculated) along with air and fuel, it won't participate in the combustion reactions. However, the exhaust gas can absorb some of the heat produced, thereby lowering cylinder temperature. Because higher temperatures strongly influence  $\text{NO}_x$  production, EGR reduces  $\text{NO}_x$  emissions substantially. The mechanics of EGR involve appropriate piping between engine exhaust and inlet systems and a control valve to regulate the amount of exhaust that is recirculated. When implemented properly, EGR can increase fuel economy under cruise conditions.

## Control Systems

### Fuel Control

To meet the conflicting goals of high power, good fuel economy, and low emissions, engine designers have had to develop high-speed, computerized engine control systems. Sensors monitor various conditions and generate information that an *electronic control module* (ECM) collects and uses to respond to driver input. Table 5.1 lists the conditions under which an ECM may monitor newer vehicles and the functions it may help control.

Table 5.1

**Conditions Monitored and Functions Controlled by the Electronic Control Module**

Conditions That May Be Monitored	Functions That May Be Controlled
<ul style="list-style-type: none"> <li>• Mass flow of intake air<sup>1</sup></li> <li>• Intake manifold air pressure</li> <li>• Intake manifold air temperature</li> <li>• Throttle position</li> <li>• Angular rate of change of throttle position</li> <li>• Engine speed</li> <li>• Camshaft or crankshaft position</li> <li>• Quantity of oxygen in the exhaust</li> <li>• Spark knock</li> <li>• Engine coolant temperature</li> <li>• Vehicle speed</li> <li>• Gear selection</li> <li>• Transmission controller</li> <li>• State of air conditioner</li> </ul>	<ul style="list-style-type: none"> <li>• Mass of fuel injected for steady state, accelerating, and enrichment conditions</li> <li>• Idle speed</li> <li>• Cold start injector, if equipped</li> <li>• Evaporative emissions control system (e.g., when to purge the charcoal canister)</li> <li>• Amount of exhaust gas recirculation (EGR)</li> <li>• Spark timing</li> <li>• Amount of boost for turbocharged vehicles</li> <li>• Input to the Automatic Braking System (ABS) computer for traction control</li> <li>• Transmission shift points</li> </ul>
<p><sup>1</sup> Measuring the mass of the intake air eliminates the need to compensate for the change of air density with altitude.</p>	

One of an ECM's most important functions is air-fuel mixture control. In a modern engine, the air-fuel mixture must be kept very close to stoichiometric for optimum performance of the three-way catalytic converter. The amount of air in the mixture is determined by throttle position and engine speed; the ECM must command the injectors to provide the corresponding amount of fuel. Fuel is provided based on input from a sensor in the intake manifold that measures the mass of intake air and feedback from the oxygen sensors in the engine exhaust. When the ECM is using these and other criteria to control the air-fuel mixture, it is operating in closed-loop mode. When an engine is cold-started, the ECM is in the open-loop mode; it is not using oxygen feedback to control engine operations because the oxygen sensors are not warm enough to be operational. When the ECM detects that the oxygen sensors are operating, it switches to the closed-loop mode.

Older vehicles used only one oxygen sensor mounted in the exhaust pipe before the under-floor catalytic converter. More recent vehicles use two oxygen sensors in each exhaust pipe, one before and another after the underfloor catalytic converter. This is to allow more precise fuel control during closed-loop operation and to monitor the condition of the catalytic converter as part of the on-board diagnostics (OBD), to be described later.



Under steady-state conditions, closed-loop control based on direct oxygen sensor input works well, but it breaks down under transient conditions. When a driver suddenly opens the throttle to accelerate, the new situation is not immediately reflected in the feedback from the oxygen sensor. Time is needed for the engine to burn the fuel mixture, for the oxygen sensor to measure the oxygen content of the exhaust, and for the ECM to command the injectors to inject more fuel. Before the release of additional fuel is triggered, the air-fuel mixture is fuel-lean, which could cause driveability and emissions problems. To compensate, under transient conditions “the ECM uses an anticipatory control strategy that uses engine load and rpm to determine the approximate fuel requirement.”<sup>3</sup> The ECM consults a data table (*map*) in its memory to determine the amount of fuel to inject for the transient combination of engine load and rpm. The map is developed by the engine manufacturer through system modeling and engine testing.

With structural variations among engines, changes that result from wear and aging, and variations in fuel characteristics, the factory-installed map can't represent the best answer. For this reason, the ECM is equipped with an adaptive learning feature that enables it to use oxygen sensor input to generate a second engine load/rpm map for current conditions. This second map is continually updated. The next time the engine reaches the same load/rpm operating point, the anticipatory control value will be closer to the correct value for the specific engine and fuel.

Several special situations require different fuel control strategies. An engine needs extra fuel, a *mixture enrichment*, for starting, for hard acceleration, and at wide-open throttle (WOT) operation. When an engine is cold, fuel vaporizes more slowly, so extra fuel is needed to ensure that combustion will occur ( $A/F = 13:1$  for optimum startability). Some injector systems use an additional cold-start injector to provide extra fuel. The cold-start injector typically operates for only a few seconds until a stable idle is achieved. Other designs simply program the port fuel injectors to inject more fuel.

Another form of mixture enrichment, called *commanded enrichment*, is used under hard acceleration and at WOT to keep the gas temperatures in the combustion chambers from becoming too hot. This helps reduce the potential for knocking and avoids overheating the catalytic converter.

Idling is a common operating condition, especially in city driving. *Idle speed* refers to power needed to run a vehicle's engine while the vehicle is not moving. To minimize fuel consumption, idle speed should be set as low as possible. It is usually controlled by adjusting the flow of air-fuel mixture, although it also can be controlled by adjusting ignition timing.

<sup>3</sup> Jurgen, Ronald K. (ed.), *Automotive Electronics Handbook*, McGraw-Hill, New York, 1995.

## Spark Control

In modern conventional engines, the initiation of a spark at the tip of a spark plug is controlled electronically by an ECM. A variety of sensors are used to determine when to initiate the spark, including those that monitor engine load (manifold air pressure), speed, coolant temperature, and atmospheric pressure. In addition, most new cars come equipped with *knock sensors* that detect knock and signal their ECMs. To eliminate knock, an ECM retards engine spark timing, that is, it fires each spark plug later in the compression stroke. This reduces peak cylinder pressure and, as a result, reduces the tendency for autoignition. The downside of timing retardation is a decrease in power. When knock is sensed in a turbocharged engine, the ECM also decreases the amount of boost to further reduce peak cylinder pressure. Boost reduction significantly decreases power. Loss of power stemming from an ECM's knock-elimination strategies can be prevented by using a gasoline with a higher AKI or RON. Some knock sensor systems have the capability to advance spark timing (as long as no knock occurs) to account for gasoline with a higher AKI or RON and to provide some additional power.

## On-Board Diagnostics

Many countries around the world now require that new vehicles have the capability to detect faults in emissions-critical equipment and controls such as the:

- Catalyst
- EGR system
- Oxygen sensor
- Coolant system
- Spark plugs
- Evaporative emissions control system

When a defect is detected, the ECM turns on a *malfunction indicator light* (MIL), often the *check engine* light on the dashboard, and stores a fault code in computer memory. The code, which can be retrieved with scanning equipment, helps a repair technician identify the faulty component.

Table 5.2

**Performance Monitored by On-Board Diagnostics**

Performance Area
<ul style="list-style-type: none"><li>• Overall catalyst system efficiency</li><li>• Evaporative control system leakage (fuel tank vapor space and vapor lines)</li><li>• Ignition misfire</li><li>• Secondary air injection system operation</li><li>• Fuel delivery system effect on emissions</li><li>• Oxygen sensor performance</li><li>• EGR system flow rate</li><li>• Electronic powertrain components that can affect emissions or are used for emission diagnostic strategies</li><li>• Air conditioning system refrigerant loss</li></ul>

Table 5.2 lists the OBD monitoring requirements for systems used in the United States. These OBD systems will likely reduce the number of vehicles on the road that have poorly running engines or defective emission control systems.

## ADVANCED ENGINE TECHNOLOGY

To help reduce exhaust emissions and fuel consumption, technology is being developed either to modify conventional engines or to provide alternatives to conventional engines. Selected items in each of these areas will be discussed in the following paragraphs.

### Conventional Engine Modifications

#### Direct Injection

The automotive industry already produces some direct fuel injection gasoline engines in which each fuel injector is mounted directly into a cylinder head combustion chamber, as shown in Figure 5.7. These engines are called *direct injection spark ignition* (DISI) engines. DISI requires fuel at much higher pressure than port injectors can provide (to overcome in-cylinder air pressure). The combustion process generally used with direct injection is a combination of *homogeneous charge* and *stratified charge*. Homogeneous charge is used for heavy accelerations and WOT operation when fuel is injected during the intake stroke to provide near stoichiometric mixtures for combustion. Light loads and cruising conditions use stratified charge, which consists of pockets of combustible mixture within a larger volume of fuel-lean mixture. The combustible mixture layer is concentrated around each spark plug. This approach results in higher thermal efficiency (lower fuel consumption and lower CO<sub>2</sub> emissions) than is possible with a conventional engine that has port fuel injection. The resulting overall fuel-lean mixtures can increase the formation of NO<sub>x</sub>. In direct injection engines, the favored method in meeting ultra-low NO<sub>x</sub> emission standards is a *lean NO<sub>x</sub> trap*. The trap is essentially a catalytic converter device that stores NO<sub>x</sub> under high-emitting conditions. Momentary combustion of slightly rich mixtures is used to reduce the stored NO<sub>x</sub>. This trap technology is being improved to help enable long-term durability. Low sulfur levels in fuel are important to extend the life of the lean NO<sub>x</sub> trap.

#### Variable Valve Timing

Another approach to reduce fuel consumption and exhaust emissions of conventional engines is ECM-controlled variable valve timing. The timing for opening the intake valve varies depending on engine load conditions. Timing is advanced under light load to increase overlap time with the exhaust valve for decreased pumping loss and internal EGR and delayed under acceleration and heavy load to reduce or eliminate overlap for maximum power output. Some systems combine variable valve timing with variable valve lift to further reduce pumping losses, approaching an unthrottled condition at light loads.

#### Cylinder Deactivation

To help meet customer demands for high fuel economy and high performance, cylinder deactivation is sometimes used, for example, to allow a large V-8 engine to operate like a smaller V-6 engine under light-load conditions. An ECM-controlled solenoid deactivates one or more intake valves during low-load conditions, the norm for most engines, to

Figure 5.7

#### Direct Fuel Injection

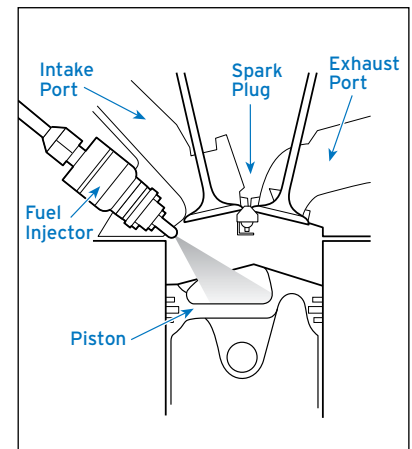

Reprinted with permission from Toyota Motor Corporation.

Figure 5.8

### Types of Hybrid Powertrain Systems

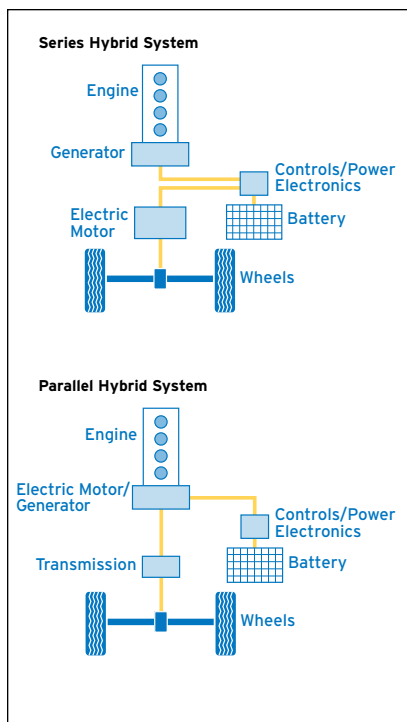

effectively reduce the size of the engine (that is, from eight cylinders to six or even four), which reduces fuel consumption. Under high-load acceleration conditions when more power is needed, more intake valves are allowed to operate as with a conventional V-8 engine.

### Variable Compression Ratio

To allow higher specific output from a smaller engine with inherently better fuel consumption characteristics, technology is being developed to vary the compression ratio for different operating conditions. Often this technology is combined with supercharging or turbocharging to further increase the specific power output. One approach for varying compression ratio is to hinge the cylinder and upper block to the lower block and crankshaft, so the two components can move relative to each other. Another approach is to use eccentric (off-center) positioning of the crankshaft axis. This technology is very complex and is still under development, so such engines aren't expected to be widely available in the near future.

### Controlled Autoignition Combustion

At this time, the concept of *controlled autoignition* (CAI) is being actively explored for advantages in potential fuel economy and exhaust emission control. A premixed air-fuel mixture is compressed to a temperature so high that autoignition occurs. This type of autoignition differs from one that produces knocking combustion because it happens at a much slower, more controlled rate. CAI is synonymous with *homogeneous charge compression ignition* (HCCI), usually referring to use with a diesel engine. CAI is difficult to control at high loads, so conventional spark ignition (SI) is usually used under such conditions. Significant hurdles still to be overcome for application of CAI include: fuel type, cold starting, control during transient operation, and smooth transition between CAI and SI modes of operation.

### Alternative Engine Technology

#### Hybrid Gasoline-Electric

A hybrid powertrain combines a gasoline (or diesel) internal combustion engine with an electric motor, generator, and storage battery. There are two types of hybrid drive systems, series and parallel (Figure 5.8). In the series configuration, a gasoline engine drives a generator to provide electrical energy for storage batteries and an electric motor, but only the electric motor drives the vehicle. In the parallel configuration, a gasoline engine drives a generator and the vehicle under low-load conditions and an electric motor is used to provide additional power for driving the vehicle under higher-load conditions. Both types of systems recover energy normally lost during decelerations and braking and use it to charge the storage batteries. Both types of hybrids are offered today, but those

under development are typically parallel hybrids. Hybrid vehicles may help meet customer expectations for very low emissions and good fuel economy, but at this stage the cost of the extra complexity and hardware compared to a conventional powertrain cannot be recovered by fuel cost savings alone over the life of the vehicle in the United States.

### Fuel Cell Electric

Perhaps the most technically advanced alternative powertrain for vehicles is the fuel cell electric. It has the potential for highest efficiency (two to three times that of conventional powertrains, but less than advanced hybrid-electric internal combustion engine powertrains) and lowest emissions (near zero) but is the furthest away from commercial reality. Besides a fuel cell stack that converts hydrogen to electrical energy, a fuel cell powertrain consists of an electrical motor/generator drive unit, storage battery, and hydrogen fuel storage, with high-pressure, liquid, or hydride options.

Alternatively, an on-board fuel reformer fed by liquid hydrocarbon fuels might be used to produce the hydrogen. A fuel cell can be thought of as a type of battery that converts chemical energy to electrical energy with electrodes (Figure 5.9). Hydrogen as the fuel is supplied to a platinum-coated anode. Oxygen from the air is fed to a platinum-coated cathode. A chemical reaction between the electrodes generates electrical current to drive a motor or for storage in a battery. The only emission products from the fuel cell to the atmosphere are water and heat – although significant emissions can also occur in making and providing the hydrogen, depending on the source. Many individual fuel cells are combined to form a fuel cell stack of sufficient capacity to drive a vehicle.

Although fuel cells are under intense development, they have many hurdles to overcome so it is not clear when they could appear in mass production. A typical estimate is sometime after 2020, although there is a wide range of opinion. Significant hurdles include: cost (about 10 times that of a conventional engine); size and weight; low temperature (sub-freezing) operation; hydrogen fuel storage and distribution infrastructure; and hydrogen cost.

Figure 5.9

### Fuel Cell Power System

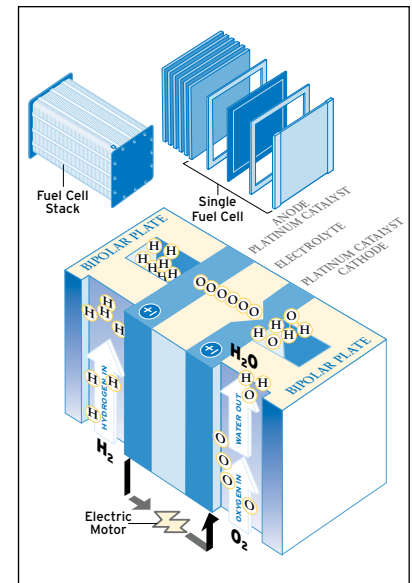

Reprinted with permission from Fuel Cell 2000, Breakthrough Technologies.



# 6 • Gasoline Vehicles – Deposit Control

Almost without exception, harmful sediment and residue would build up inside an engine if commercial gasolines did not contain effective deposit control (DC) additives. Some of today's additives not only help keep vital engine parts clean, they can also remove existing deposits. Because almost all base gasolines are formulated to the same regulated specifications (see page 44), the performance of their DC additives is a key distinguishing feature.

## ENGINE DEPOSITS AND PERFORMANCE

Figure 6.1 shows the critical areas of deposit formation in an engine and the associated impact on performance.

**Fuel Injectors and Carburetors** Fuel injectors are designed to accurately meter fuel into an engine's airstream in a precise pattern of fine droplets. Because of their narrow fuel passages, injectors are highly sensitive to small deposits in the regions where fuel is metered and atomized. These deposits, which may be any combination of dirt, rust, or degraded gasoline, can reduce fuel flow and alter the spray pattern, which can degrade driveability, decrease power and fuel economy, and increase exhaust emissions. Deposits cause similar problems for carbureted engines because carburetors also use a number of small channels and orifices to meter fuel.

Port fuel injector (PFI) deposits form during the *hot soak* period after an engine has been turned off. The gasoline trapped in an injector tip is exposed to a higher temperature for a longer time than the gasoline that flowed through the injector when the engine was running. The heat degrades the gasoline into a hard varnish, initiating deposit formation. In the absence of an effective additive, injector deposits form quite rapidly if a base gasoline is relatively unstable and if a vehicle is used predominantly for short trips. Figure 6.2 shows a close-up of deposits on the director plate of a gasoline injector tip.

**Intake Valves and Ports** Because valves and ports operate at high temperatures in the very reactive environment of a running engine, they are susceptible to deposit formation. Heavy deposits on valves and ports restrict air flow and alter air flow patterns within a cylinder, which reduces engine power. In some sensitive fuel-injected engines, even low levels

Figure 6.1

Location and Performance Effects of Engine Deposits

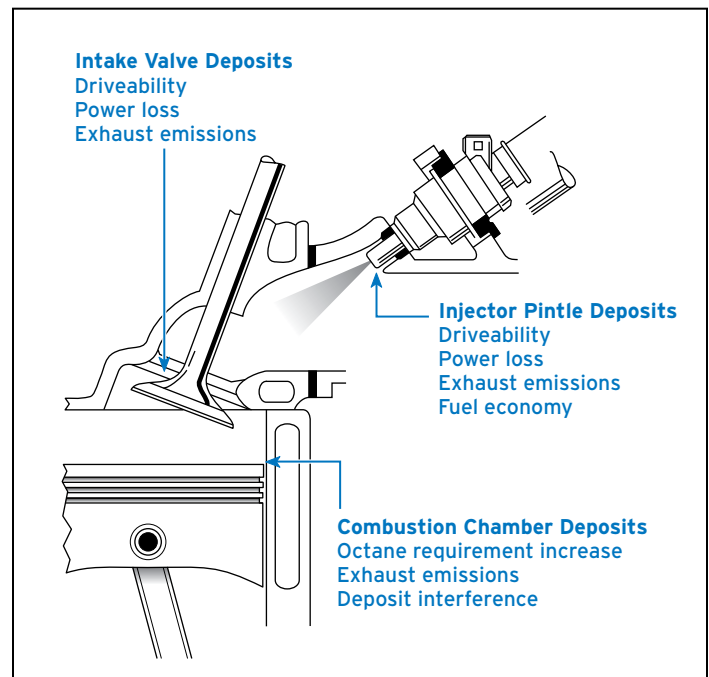

Figure 6.2

Port Fuel Injector Director Plate Deposits

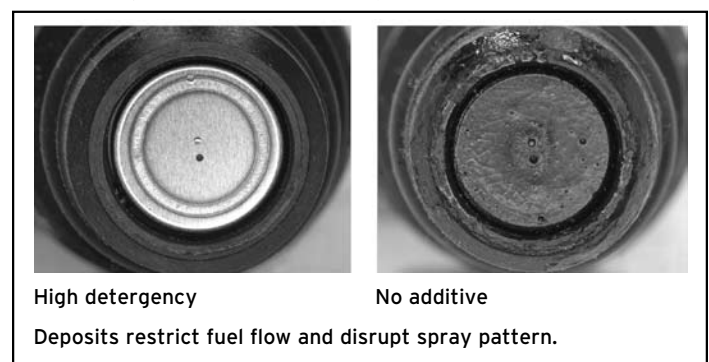
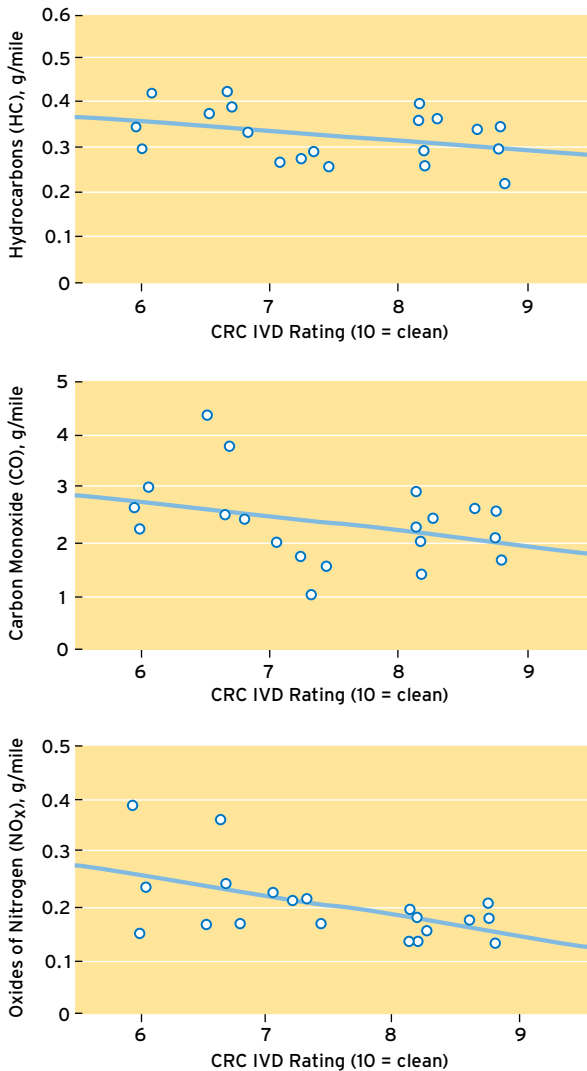



Figure 6.3

### Intake Valve Deposits Increase Tailpipe Emissions



Emissions were measured by Federal Test Procedure Cycle (FTP 75); results are average results for a 20-car fleet.

Reprinted with permission from SAE Paper No. 922259  
© 1992 Society of Automotive Engineers, Inc.

of intake valve deposits (IVD) can hurt performance. Cold-start and warm-up driveability (see page 3) can be adversely affected and exhaust emissions can increase. In fact, the emissions increase can be surprisingly high (Figure 6.3) because deposits momentarily absorb and then release fuel, which upsets the delicate air-fuel ratio (A/F), particularly during transient cycles. The altered A/F not only increases emissions coming out of the engine but also impedes the conversion efficiency of the catalytic converter. Other valve deposit problems include valve sticking (when deposits interfere with a valve stem sliding in its guide) and burned valves (when severe deposits prevent a valve from seating properly). Figure 6.4 shows different levels of IVD common in today's engines.

**Combustion Chamber** When an engine is brand-new, its octane number requirement (ONR) is determined by the quality of its design and manufacture. Generally, the engine will not knock while operating on gasoline with the antiknock quality prescribed by the manufacturer. The engine's ONR increases, however, as combustion chamber deposits (CCD) form during the first several thousand miles of operation (see page 8 and Figure 6.5). If the ONR increase is large enough, the recommended gasoline AKI may not prevent knocking or, if the vehicle is equipped with a knock sensor, the loss of power that accompanies knock suppression (see page 72).

Combustion chamber deposits increase ONR in two ways: They increase combustion temperature by transferring heat to the incoming air-fuel mixture and by slowing heat transfer from the combustion gases (thermal insulation). In addition, they increase the compression ratio because their bulk volume reduces the volume of the combustion chamber when its piston is at top dead center (TDC). The increase in compression ratio has a much smaller effect on octane requirement increase (ORI) than the rise in combustion temperature.

Research shows that precursors for CCD come from fuel, some fuel additives, and engine oil and that certain fuel and engine oil components form more deposits than others. To date, the only quick, effective means of removing these deposits is to treat gaso-

line with an aftermarket DC additive concentrate based on polyether amine chemistry. Aftermarket DC additive concentration in a treated tank of gasoline is 10 times to 20 times higher than that of service station gasoline. With such a change in chemistry, one tankful of treated gasoline can decrease ORI 30 percent to 40 percent. Periodic treatment is required because deposits reform with additional driving and the ONR gradually returns to the previous equilibrium level.

Combustion chamber deposit interference (CCDI) and combustion chamber deposit flaking (CCDF) are two other problems that sometimes occur in certain modern engines. CCDI is the result of physical contact between deposits on a piston top and the cylinder head and is manifested as a loud, metallic banging sound when an engine is cold. CCDI is limited to engines that have been designed with minimal clearance (1 millimeter or less, primarily to reduce emissions) between some areas of the piston tops and the cylinder head (*squish* areas) when the pistons are at TDC. CCDF causes low compression pressures when flakes from deposits lodge between a valve's face and its seat, preventing the valve from sealing properly. Engine symptoms of CCDF are difficulty in starting and rough running when cold.

## HISTORICAL DEVELOPMENT OF DEPOSIT CONTROL ADDITIVES<sup>1</sup>

**Carburetor Detergent** This class of additives consists of relatively inexpensive low-molecular-weight surfactants used at low concentrations. When introduced in 1954, they were effective in preventing and, in many cases, removing deposits from carburetor throttle bodies. These detergents could not, however, handle deposits in other carburetor parts, such as air bleeds, or other intake system sections. The introduction of positive crankcase ventilation (PCV) and exhaust gas recirculation (EGR) emission control systems in the vehicles of the 1960s and 1970s increased deposit levels throughout their intake systems (see pages 64 and 69). As a result, carburetor detergents were not as effective as they were in the simpler vehicles of the 1950s.

**Detergent-Dispersants** This class of additives consists of polybutene succinimides. Additives with similar chemistry had been used widely as engine oil dispersants before the chemistry was applied to gasoline in 1968. Detergent-dispersants are higher-molecular-weight materials used at concentrations three times to five times higher than carburetor detergents. Their performance was sometimes improved by using them in combination

Figure 6.4

### Typical Intake Valve Deposits

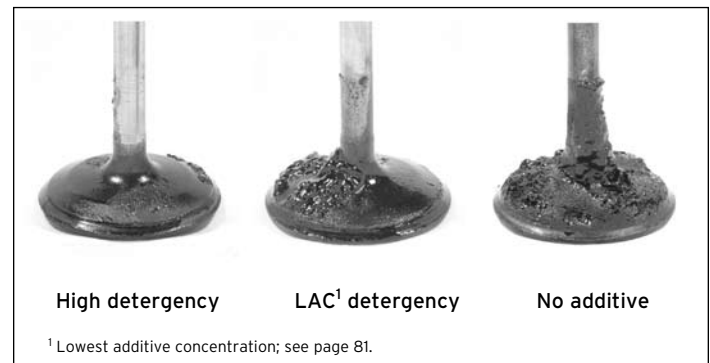

Figure 6.5

### Typical Combustion Chamber Deposits



<sup>1</sup> Gibbs, L.M., "Gasoline Additives – When and Why," Paper No. 902104, Society of Automotive Engineers, Warrendale, Pa., 1990.

---

### **Performance Categories**

*There are two performance categories for deposit control additives: keep-clean and cleanup. In tests, keep-clean performance refers to how clean a part of interest is after a clean engine runs on additized fuel. Cleanup performance refers to how well additized gasoline reduces deposits on a part of interest in an engine that was previously run on lower-quality gasoline. Cleanup performance is more demanding than keep-clean performance.*

with a petroleum carrier oil. They provided keep-clean performance for the intake manifold and intake ports. But they couldn't control intake valve deposits and had poor carburetor and fuel injector cleanup performance.

**Deposit Control (DC) Additives** The first additive of this class was introduced in 1970. It is based on polybutene amine chemistry and is used in combination with a carrier fluid. While they have to be used at higher concentrations than detergent-dispersants, DC additives provide benefits throughout an engine's intake system. They clean up, and keep clean, the throttle body and upper areas of the carburetor, fuel injectors, intake manifold, intake ports, and intake valves.

Lead salts are a combustion catalyst for carbon, so the shift to unleaded gasoline changed the nature of CCD. When first-generation DC additives were used in unleaded gasoline, they continued to control intake system deposits but increased CCD. Consequently, a second-generation DC additive designed specifically for use with unleaded gasoline was developed and introduced in 1980. It was based on new polyether amine chemistry, which provides excellent deposit control performance throughout the intake system without contributing to CCD or causing any other adverse side effects.

### **NO HARM AND COMPATIBILITY**

DC additives are used at concentrations that are 20 times to 50 times higher than the concentrations of other gasoline additives (see page 41). At these higher concentrations, they have the potential to affect gasoline properties, fuel system materials, and engine oils. Therefore, DC additives are tested for the absence of negative attributes (*no harm*) as well as for the positive attribute of controlling deposits. Additized fuel must be fully compatible with the elastomers and metals it will contact. In addition, it must be compatible with other gasoline additives, tolerate water well, and not contribute to spark plug fouling, crankcase sludge formation, or intake or exhaust valve sticking.

### **EMISSIONS**

At some level, carburetor, injector, intake port, valve, and combustion chamber deposits all increase engine emissions (see Chapter 2, "Gasoline and Air Quality"). For example, Figure 6.3 illustrates that hydrocarbon, CO and NO<sub>x</sub> tailpipe emissions are lower when intake valves are cleaner.

## REQUIRED ADDITIVE USE

As a result of the relationship between decreased deposits and decreased emissions, all motor gasoline sold in the United States must contain an additive that provides a minimum level of deposit control performance. This requirement was established by the Clean Air Act Amendments of 1990 and became effective in January 1995. A similar requirement has been in effect in California since January 1992. Additive manufacturers are required to obtain U.S. Environmental Protection Agency (EPA) certification for their additives. Each certification request must include documentation of the additive's effectiveness in specified fuel injector keep-clean and intake valve keep-clean tests (see sidebar) when evaluated with specified test fuels. A similar detergency requirement exists in Thailand.

Before selling any gasoline in the United States, gasoline marketers must add a certified DC additive to their gasoline at the certification concentration level or higher. The minimum certification concentration level is referred to as the lowest additive concentration, or LAC. This dosage is not very effective in controlling deposits in certain fuels and engines. Higher concentrations provide improved performance, such as the ability to change keep-clean performance to cleanup performance. Historically, some gasoline brands have provided much higher deposit control performance than the minimum level of certification performance required by the U.S. EPA. For competitive reasons, they probably will continue to do so.

## TOP TIER DETERGENT GASOLINE

Six of the world's major automobile manufacturers, BMW, General Motors, Honda, Toyota, Volkswagen, and Audi, believe that detergent additives used at the U.S. EPA's minimum certification level, LAC, do not provide sufficient deposit control to help enable optimal engine performance. To inform consumers of the higher level of performance these automakers believe is needed, a further gasoline/additive qualification system has been developed and covers:

- Intake valve keep-clean
- Combustion chamber deposits
- Fuel injector fouling
- Intake valve sticking

### **U.S. Additive Certification Tests**

*The fuel injector keep-clean test was developed by the Coordinating Research Council (CRC, see page 45) and established as ASTM D5598 Standard Test Method for Evaluating Unleaded Automotive Spark-Ignition Engine Fuel for Electronic Port Fuel Injector Fouling. The method uses a 1985-1987 model Chrysler vehicle equipped with a 2.2L, 4-cylinder, turbocharged engine. To test a fuel, the vehicle operates through more than 720 one-hour cycles for a total of 10,000 miles, after which no injector may have greater than a 5 percent flow restriction.*

*The intake valve keep-clean test was adapted from one developed by BMW and the Southwest Research Institute and established as ASTM D5500 Standard Test Method for Vehicle Evaluation of Unleaded Automotive Spark-Ignition Engine Fuel for Intake Valve Deposit Formation. The method uses a 1985 model BMW 318i vehicle. After the vehicle operates through a cycle of mixed city, suburban, and highway driving for 10,000 miles, the average IVD weight must not exceed 100 mg per valve to meet federal requirements and 50 mg per valve to meet California requirements. California places an additional requirement on CCD using this same test procedure.*

---

### **TOP TIER Detergent Gasoline Tests**

*The intake valve keep-clean test was developed by the CRC and adopted by ASTM as D6201 Standard Test Method for Dynamometer Evaluation of Unleaded Spark-Ignition Fuel for Intake Valve Deposit Formation. This test method is also used to determine CCD. The procedure uses a 1994 Ford Ranger 2.3L engine operating on a two-stage test cycle for 100 hours. IVD cannot exceed 50 mg on average over all valves. CCD cannot form more than an average of 140 percent that of base gasoline without additive. The injector fouling test developed by General Motors uses a GM intermediate van. To qualify a special fuel, no more than one injector can be inoperative. The intake valve sticking test method uses either a 1.9L Volkswagen engine (Wasserboxer according to CEC F-16-T-96) or a 5.0L 1990-1995 General Motors V8 engine (SwRI IVS test method). The passing requirement is to have no stuck valves during any of the test's three cold starts.*

Gasolines that meet the standards qualify to be categorized as TOP TIER Detergent Gasoline. The engine tests required by the standards (see sidebar) provide a more stringent assessment of additive performance than U.S. EPA certification. In addition, TOP TIER Detergent Gasoline is not permitted to contain metallic additives, including methylcyclopentadienyl manganese tricarbonyl (MMT).

### **AFTERMARKET ADDITIVES<sup>2</sup>**

Engine deposits are affected by engine design, driving conditions, gasoline base fuel quality, and gasoline additives. Although all gasoline must contain a DC additive, some additives are less effective than others or are used at minimum concentration levels. In addition, some engine designs promote heavier deposits than others, and some engine designs are extremely sensitive to deposits that do form. Aftermarket DC additives can clean up deposits that form as a result of these factors. Treating one tankful of gasoline with an aftermarket additive is often sufficient. However, chemistry and dosage greatly influence the effectiveness of an additive. Polyether amine-based aftermarket additives have been shown to be particularly effective at providing both excellent intake system and CCD cleanup.

<sup>2</sup> Aftermarket additives are intended to be added by the consumer to a gasoline (or oil) already in the consumer's vehicle.

# Handling Gasoline Safely<sup>1</sup>

---

First and foremost, gasoline is highly flammable. It is easy to ignite, and it burns explosively. Second, exposure to gasoline liquid or vapor has possible adverse health effects.

All manufacturing companies of applicable chemicals in the U.S. are required to develop and make available safety information about their products. You may obtain a Material Safety Data Sheet (MSDS) for Chevron gasoline by calling 800-689-3998. Chevron MSDSs are also available on the Internet; go to <http://www.chevron.com/products/sitelets/msds/>, choose a region link, and then search for *gasoline*. The MSDS provides detailed information on the potential hazards associated with gasoline and the appropriate responses.

Chevron's MSDS for gasoline contains the following human health warnings:

## EMERGENCY OVERVIEW

- EXTREMELY FLAMMABLE LIQUID AND VAPOR. VAPOR MAY CAUSE FLASH FIRE.
- HARMFUL OR FATAL IF SWALLOWED – MAY CAUSE LUNG DAMAGE IF SWALLOWED.
- VAPOR HARMFUL.
- CAUSES EYE AND SKIN IRRITATION.
- LONG-TERM EXPOSURE TO VAPOR HAS CAUSED CANCER IN LABORATORY ANIMALS.
- KEEP OUT OF REACH OF CHILDREN.

## Fueling a Vehicle

Safety tips when fueling a vehicle:

- Shut off the vehicle's engine.
- Do not smoke.
- Use only the hold-open latch provided on the pump nozzle if you want to refuel without continually squeezing the nozzle lever. Never jam the nozzle lever with any object (such as a gas cap).
- Never leave the open nozzle unattended.
- Do not overfill or top off the tank.
- Never let children fuel the vehicle.
- Leave cell phones and other electronic devices turned off and in the vehicle.

<sup>1</sup> Chevron does not claim that the information contained in this document is complete or without error. Nor does Chevron represent that the information herein for handling gasoline will ensure compliance with all governmental requirements. You should consult the applicable MSDS, actual laws and regulations, and other sources of information for understanding and complying with all regulations in regards to the subject matter of this document.

---

Although rare, a static electricity-related fire could occur while someone is filling a vehicle's gas tank and cause injury or property damage. Static electricity is more likely to build up on your person in cold, dry climatic conditions. After exiting a vehicle to refuel it, *always touch a metal part of your vehicle* (such as a door or fender away from the gas tank opening) with a bare hand before you begin fueling. To help avoid buildup of static electricity, do not reenter your vehicle during refueling. If you cannot avoid reentering the vehicle, upon exiting, *always touch a metal part of the vehicle* away from the fill point before handling the nozzle.

In the unlikely event that a fire starts while you're refueling, leave the nozzle in the fill pipe and back away from the vehicle. **Notify the station attendant immediately;** the attendant is able to use the emergency controls to shut off all dispensing devices and pumps. If necessary, you may use the emergency shutdown button, located on the building exterior and/or canopy columns, to shut off the pump.

### Filling a Container

Several fires have reportedly started at service stations when customers placed portable containers on plastic bed liners in pickup trucks while filling the containers with gasoline. Filling a container with gasoline is a special situation that requires extra precautions:

- Use only a UL-approved container (red for gasoline).
- Shut off the vehicle's engine.
- Place the container on the ground a safe distance from the vehicle, other customers, and traffic. Don't fill a container in or on a car or truck.
- Keep the pump nozzle in contact with the container during filling.
- Manually control the pump nozzle valve; do not latch it open.<sup>2</sup>
- Do not smoke.
- Avoid breathing gasoline fumes.

Flowing gasoline generates a static electric charge that builds up on the gasoline in the receiving container. If the charge isn't given an opportunity to dissipate, it could jump from the container to the metal spout of the pump nozzle as a static spark. If a spark occurs near the open mouth of the container where the concentration of gasoline vapor and air is in the flammable range, it could ignite the gasoline.

Putting the container on the ground and keeping the pump nozzle in contact with the container helps dissipate the static charge and reduce the risk of causing a spark. The charge will dissipate more slowly from a container being filled on an insulating surface –

<sup>2</sup> If the nozzle is fitted with a fume-recycling device, the device must be compressed to activate the dispenser.



carpet in the trunk of a car and on the bed of a utility vehicle or the plastic bed liner of a pickup truck. Placing the container on the ground has the secondary benefit that an accidental spill won't contaminate the vehicle.

Fill the container only about 95 percent full. This leaves room for the gasoline to expand if it warms up in storage. Without space to expand, the vaporizing gasoline will create pressure that will distort the container and even force liquid gasoline out of it.

### Transporting Gasoline

Do not transport a container of gasoline in the interior of a vehicle. Before putting a container of gasoline in the trunk of a vehicle or the back of a pickup, tighten the cap of the container and the cap of the air vent, if there is one. Wipe the outside of the container with a towel to remove any liquid gasoline or gasoline residue. Dispose of the towel in the receptacle provided at the service station; do not leave it in the vehicle or on the ground. Secure the container in the trunk or pickup bed so it won't slide around or tip over when the vehicle turns or vibrates. Do not leave a container of gasoline in direct sun on a hot day or in the trunk of a car that is in direct sun on a hot day. Heating the gasoline will build up pressure in the container.

### Storing and Handling Gasoline

Minimize the danger of spills by storing containers of gasoline at ground level.<sup>3</sup> To help avoid an accidental fire, keep gasoline away from any ignition source (flame or spark) and any ignition source away from gasoline. There should not be an appliance pilot light or igniter within 50 feet (15 meters) of where gasoline is stored or handled. Gasoline fumes, which are invisible and heavier than air, can travel along the floor for some distance when they are not dispersed by air currents. If ignited, the fumes become a fuse that brings the flame back to the liquid gasoline source. Therefore, handle gasoline only in a well-vented area. For both fire and health considerations, it is best to handle gasoline outdoors. Ignition sources are less prevalent, and the fumes are diluted and dispersed more quickly.

To avoid eye and skin contact, wear safety glasses and gasoline-resistant gloves while handling gasoline.<sup>4</sup> Minor spills should be absorbed with sawdust, paper, or rags. Place recovered gasoline and cleanup materials in labeled containers for proper disposal. Check with your local government or hazardous-waste disposal center to determine the proper avenues for disposal.<sup>5</sup>

<sup>3</sup> "Outdoor Air – Transportation: Gas Cans – Additional Information," U.S. EPA, [http://www.epa.gov/air/community/details/gascan\\_addl\\_info.html](http://www.epa.gov/air/community/details/gascan_addl_info.html).

<sup>4</sup> Gloves made of nitrile, polyurethane, Viton®, or chlorinated polyethylene (CPE) are gasoline-resistant.

<sup>5</sup> "Safety in Your Home: Tips for Safe Storage and Disposal of Gasoline," American Petroleum Institute, <http://www.api.org/ehs/health/home/index.cfm>.

---

## First Aid

**Eye Contact:** Flush eyes immediately with fresh water for at least 15 minutes while holding the eyelids open. Remove and clean or discard contact lenses, if worn. If irritation persists, see a doctor.

**Skin Contact:** Wash skin thoroughly with soap and water. Remove and wash contaminated clothing. See a doctor if skin irritation is severe.

**Inhalation:** If respiratory irritation or nervous system effects (headache, dizziness) occur, move yourself or the person affected to fresh air. If any of these effects continue, see a doctor.

**Ingestion:** If swallowed, drink water or milk and telephone for medical advice. DO NOT induce vomiting unless directed to do so by medical personnel. If medical advice cannot be readily obtained, go to the nearest medical emergency treatment center or hospital. Find someone else to do the driving if you're the one affected.

**Emergency Information:** Call your local poison control center. You can also call the Chevron Emergency Information Center, where toxicology information and advice is available 24 hours a day:

Inside the U.S. and Canada: 800-231-0623

Outside the U.S.: + 1-510-231-0623

## Using Gasoline

Gasoline should be used only as an engine fuel. It should not be used as a solvent, cleaner, fireplace accelerant, or barbecue starter or for any purpose other than fueling an engine.

Chevron strongly recommends AGAINST use of gasoline by children or individuals without specialized training and proven reliability for safely handling hazardous substances. The risks are too great for anyone who is not completely familiar with the hazards. Gasoline never should be brought into the living space of a house or taken to school.

## Disposing of Gasoline

Do not dispose of gasoline by pouring it onto the ground or into a sewer, street drain, stream, or river. These actions may violate federal, state, and local laws, are harmful to the environment, and may result in a fire or explosion.

Excess gasoline in good condition can be added to the fuel tank of a gasoline-powered car or truck. (Don't dispose of gasoline/oil mixtures for two-stroke cycle engines this way.) Use a funnel with a flexible stem to direct the gasoline past the flap valve into the filler tube of newer vehicles. The funnel will help prevent gasoline from spilling on the vehicle. Oxygenated gasoline can damage the finish on some vehicles. Flexible stem funnels are available at most auto supply stores.

It's not as easy to get rid of gasoline that has deteriorated. Some organizations will dispose of gasoline in an environmentally responsible way, but finding the best option may take some research. Sources of information include your community's fire department, recycling center, and hazardous-waste disposal center. Check the government pages of your telephone book to locate these organizations. Commercial organizations are listed in the Yellow Pages under *Environmental & Ecological Services* and *Oils, Waste*. You may have to pay for the disposal, but any fee is likely to be less than the cost to repair or replace an engine run on bad gasoline and is a small price to pay to help protect people and the environment.



# Questions and Answers

---

## What is gasoline?

Gasoline is the fuel designed for spark-ignition internal combustion engines. In some parts of the world, it is called *petrol*. Conventional gasoline is a mixture of compounds called hydrocarbons, derived from petroleum crude, plus small amounts of a few additives that improve fuel characteristics, such as stability, and control deposit formation in engines.

## What is oxygenated gasoline?

Oxygenated gasoline is conventional gasoline to which oxygenates have been added to increase octane and, as required by regulation, to reduce emissions or to comply with renewable fuel standards. Oxygenated gasoline is required in the U.S. during winter in those metropolitan areas that do not meet the federal air quality standard for carbon monoxide (carbon monoxide nonattainment areas). Reformulated gasolines (RFGs) in the U.S. are generally oxygenated year-round, not just during the winter months. Common oxygenates are ethanol and methyl tertiary butyl ether (MTBE). Other ethers that may be used are tertiary amyl methyl ether (TAME) and ethyl tertiary butyl ether (ETBE).

## Will oxygenated gasoline perform as well as conventional gasoline in my vehicle?

Oxygenated gasoline will perform as well as conventional gasolines in modern vehicles with engine control systems that adjust the air-fuel ratio (A/F). Oxygenated gasoline may cause some driveability problems in carbureted cars and fuel-injected cars without engine control systems because the air-fuel mixture is more fuel lean. The use of oxygenated gasoline can reduce fuel economy up to 3 percent, depending on the level of oxygenate in the fuel.

## What is reformulated gasoline?

Reformulated gasoline in the U.S. is a gasoline blended to reduce evaporative and exhaust emissions from vehicles. The characteristics of the gasoline are specified by regulation, either directly or by a model that relates gasoline characteristics to emissions. Federal regulations differ somewhat from those established by the state of California. Federal RFG requirements apply to those metropolitan areas that do not meet the federal air quality standard for ozone (ozone nonattainment areas). RFG is required throughout the state of California. Although federal regulations no longer require RFG to be oxygenated year-round, it generally has to comply with the federal Complex Model. The California Predictive Model also allows for non-oxygenated California RFG.

## Will RFG perform as well as conventional gasoline in my vehicle?

If the RFG is oxygenated, the answer for oxygenated gasoline performance applies. The use of oxygenated RFG will reduce fuel economy, on average, by 2 percent to 3 percent. Regulations require RFG to have low vapor pressure during summer, which could make starting a cold engine more difficult on unseasonably cold days in spring.

---

### When RFG is oxygenated, doesn't its reduced fuel economy counteract its emissions benefit?

The emissions benefit of oxygenated RFG was determined by testing in fleets of actual vehicles. The test vehicles saw the same fuel economy loss that your car sees. Because emissions are measured in units of grams per mile in the U.S., the emissions benefit for RFG already includes any effect on fuel economy.

### Why did my fuel economy drop much more than 2 percent to 3 percent when I began using oxygenated RFG?

The 2 percent to 3 percent fuel economy loss for oxygenated RFG was determined by extensive laboratory testing and has been validated by independent organizations such as the California State Automobile Association. The fuel economy loss also is in line with the decrease in the heating value of RFG compared to non-oxygenated conventional gasoline. A decrease in fuel economy much greater than 2 percent to 3 percent could be the result of a mistuned engine or of comparing fuel economy results obtained under weather or driving conditions that differ from those encountered in testing.

### What is knocking?

Spark knock is the sound of abnormal combustion. As suggested by its name, an internal-combustion, spark-ignition engine initiates combustion with a spark. The spark's flame front should fan out from the spark plug and travel across the combustion chamber rapidly and smoothly. If the air-fuel mixture ignites spontaneously (autoignites) before the flame front arrives, the sudden jump in the pressure in the cylinder creates the characteristic knocking or pinging sound. Knocking occurs because the octane number of the gasoline in use is below the antiknock requirement of the engine.

### Can knocking harm my engine?

Occasional light knocking won't harm an engine. Heavy or prolonged knocking can result in loss of power, overheating of parts in the cylinder, and engine damage.

### What is octane number?

Octane number reflects a gasoline's antiknock quality. It's a measure of the ability of the gasoline to resist knocking when it is burned in an engine. Laboratory testing that determines a gasoline's octane number involves burning the fuel in a single-cylinder engine under different conditions to yield a Research octane number (RON) and a Motor octane number (MON). The octane number posted on U.S. gasoline dispensers in service stations is the antiknock index (AKI) – the average of RON and MON  $[(RON + MON)/2]$ , usually abbreviated  $(R + M)/2$ . The AKI was chosen as the posted value in the U.S. because it proved to be the best indicator of the antiknock performance of gasoline in the majority of U.S. vehicles. In other parts of the world, RONs are frequently posted on gasoline pumps.

### What octane grade gasoline should I use in my vehicle?

For starters, use a gasoline with the AKI or RON recommended in your owner's manual. (A rule of thumb is that the RON of a gasoline equals the AKI + 5.) Using gasoline with an antiknock rating higher than that required to prevent knock will not improve a vehicle's performance, including its power, unless the vehicle is equipped with a knock sensor and programmed to take advantage of the higher octane.

Your vehicle might knock when running on a gasoline with the AKI or RON recommended in the owner's manual because:

- The engine is at the upper end of the octane number requirement (ONR) range. The ONR of each engine differs slightly among vehicles of the same make and model because of variations in manufacturing tolerances.
- The ONR of the engine increased more than usual because the equilibrium level of the combustion chamber deposits is higher than usual.
- The engine or engine control system has a mechanical or electrical problem.

In a modern vehicle, a driver may never hear knocking when the AKI or RON of the gasoline in use is lower than the ONR of the engine. This is because the engine is equipped with a knock sensor that temporarily retards spark timing to prevent knock. This adjustment will result in loss of power and acceleration. In this case, switching to a gasoline with a higher AKI or RON will help improve performance and increase power. Before making a permanent change, have a mechanic determine whether the emissions control system is functioning properly.

### Why do the gasolines in different U.S. states have different AKI values?

The AKIs of the gasolines offered for sale are set by gasoline refiners and marketers based on their perception of the technical and competitive needs in the market. U.S. and most state regulations do not address AKI minimum values but specify only that dispenser postings accurately reflect the AKIs of the gasolines being sold. The AKI of premium gasoline in some states is higher than it is in others. This is the result of competition. The AKI of all grades of gasoline is lower in the high-altitude areas of some Rocky Mountain states. This is because the octane requirement of older engines without engine control modules decreases with altitude. At higher altitudes, these engines perform as well on the lower-AKI gasolines as they would at sea level on higher-AKI gasolines.

### What will happen if I use the wrong octane number gasoline in my vehicle?

Using a gasoline with an AKI or RON lower than that required by your vehicle will cause the engine to knock or, if the engine is equipped with a knock sensor, decrease the vehicle's power and acceleration. Using a gasoline with an AKI or RON higher than that required by your vehicle will not benefit your vehicle.



---

### How can I stop my vehicle from knocking?

Have a mechanic determine whether your engine is in tune and the emissions control system is functioning properly. If it is, then there are two courses of action:

1. Use a gasoline with a higher AKI or RON.
2. Treat the gasoline with an aftermarket deposit control (DC) additive concentrate based on polyether amine chemistry. If the engine has combustion chamber deposits, the treatment will reduce them, which in turn will lower the octane requirement of the engine and decrease its tendency to knock until deposits form again.

### How can I increase the octane number of premium unleaded gasoline for use in my 1969 high-compression-ratio engine designed to use high-test (95 AKI) premium leaded gasoline?

Additives available in auto parts stores will increase the octane number of unleaded premium gasoline. The products that contain high-octane aromatics with or without MTBE do not provide much benefit because the volume being added is too small. The products that contain a manganese antiknock additive will provide an increase in octane number that could help solve your problem. However, the increase will probably not be great when added to premium unleaded gasoline, as suggested on the label.

### What is the difference between one company's gasoline and another's?

Company to company, the gasolines sold within a geographical area sometimes differ by AKI or RON. The DC additives they contain may vary, too. Federal regulations require that all gasolines in the U.S. contain a DC additive. The minimum amount of additive needed in a gasoline for U.S. EPA certification is called the lowest additive concentration (LAC) level. Many companies use the LAC level in their gasolines. Gasolines that provide better DC performance than others are blended with DC additives that are more effective, have fewer side effects, or are added at higher concentrations (or any combination of these three possibilities). Gasolines qualified as TOP TIER Detergent Gasolines have the highest DC performance level.

### Do engine deposits really make a difference?

Deposits in carburetors or on fuel injectors can affect the A/F of an engine as well as individual cylinders, which in turn can affect driveability, fuel economy, and emissions. Intake valve deposits also can affect emissions and, if heavy enough, can reduce power. Combustion chamber deposits affect ONR and can affect some emissions. The U.S. government and the state of California require the use of DC additives in gasoline because deposits can affect emissions.

### Do I need to add an aftermarket DC additive to the gasoline in my fuel tank?

If you regularly use a gasoline with superior-quality DC performance, the use of an after-market DC additive should not be necessary unless your engine is particularly susceptible to deposit formation (because of its design or because of driving conditions). If you regularly or occasionally use gasolines with lower-quality DC performance, the addition of a DC concentrate to the gasoline in your vehicle's fuel tank every 4,500 km (3,000 miles) may help reduce knocking, increase acceleration and power, and reduce emissions.

### How will unleaded gasoline affect my older vehicle with an engine designed to be operated on leaded gasoline?

Pre-1971 U.S. vehicles were designed to operate on leaded gasoline (which is banned from sale in the U.S. and elsewhere). The original exhaust valve seats in these engines were not hardened and not equipped with metal alloy inserts. The lead in the gasoline not only functioned as an antiknock additive but served as a lubricant that kept the exhaust valves from wearing away the valve seat (exhaust valve seat recession) under certain severe operating conditions.

Driving around town or at normal highway speeds with unleaded gasoline in a pre-1971 vehicle will not result in exhaust valve seat recession. However, travel that raises the engine's operating temperature will. This includes heavy towing and high-speed and uphill driving for extended periods. If a trip is going to involve one or more of these situations and the pre-1971 vehicle hasn't been equipped with metal alloy exhaust valve seats, consider using a lead-substitute aftermarket additive. Consult the engine manufacturer before using the additive. In some countries, a lead-replacement gasoline (petrol) is offered that contains protective additives.

### What can I do to optimize fuel economy?

Good fuel economy is a combination of consistent vehicle maintenance and sensible driving. Maintenance factors that contribute to good fuel economy are a properly tuned engine, a clean air filter, aligned and balanced front wheels, and tires with the correct air pressure. Because mistuned engines can result in higher emissions, the on-board diagnostic system in a modern car will alert you to an engine problem.

Sensible driving involves smooth, steady acceleration and moderate highway speeds.

It does *not* involve:

- Unnecessarily carrying a heavy load, using a luggage rack, or towing a trailer.
- Using the air conditioner or defroster excessively.
- Idling the engine when it could be turned off.

Some factors that reduce fuel economy are beyond your control: water, slush, or snow on the road, head winds, inclines, and stop-and-go traffic.

---

### Will premium gasoline give better fuel economy than regular?

### Will one brand of gasoline give better mileage than another?

Gasolines with higher heating values can improve fuel economy. Mileage differences may exist, but they will be small compared to the benefits to be derived from the maintenance and driving tips mentioned earlier.

Traditionally, premium gasoline has had a slightly higher heating value than regular, and, thus, provided slightly better fuel economy. Its mileage difference, less than 1 percent better, is not large enough to offset premium's higher cost. The difference is likely to be less or nonexistent between grades of RFG.

There can be variance in heating value between batches of gasoline from the same refinery or between brands of gasoline from different refineries because of compositional differences. The variance is small, and there is no practical way for the consumer to identify the gasoline with a higher heating value.

### How long can I store gasoline without it going bad?

Gasoline stored in a tightly closed container in a cool place will retain its quality for at least one year. Fill the container only about 95 percent full. This leaves room for the gasoline to expand if it warms up in storage. If the container will be in direct sun or will be heated above 30°C (80°F) much of the time, add an aftermarket fuel stabilizer when you fill it with gasoline. Gasoline-oil blends for two-stroke-cycle engines stored under the proper conditions will keep as well as gasoline itself.

### Can I use motor gasoline in my airplane?

Chevron recognizes that some planes are certified (Supplemental Type Certificate [STC]) to use fuel with the same octane number as motor gasoline. The gasoline these planes use must meet the requirements of gasoline specification ASTM D4814 and must not contain ethanol.

Chevron strongly recommends AGAINST using motor gasoline in place of aviation fuel.<sup>1</sup> Because of the serious consequences of aircraft engine failure, aviation fuels are formulated to unique standards, with extra attention given to retaining purity and cleanliness. To keep ground vehicles clean, motor gasolines are formulated with deposit control additives – products that have not been approved for use in aviation fuels and could have a detrimental effect on aircraft engine performance. In addition, motor gasolines that contain oxygenates are problematic. Ethanol, an oxygenate widely used today, is not suitable for and can be dangerous in aviation applications. STCs that allow the use of motor gasoline in planes do not and were not created to address such an issue. Risk is compounded in areas where regulations do not require that motor gasoline pumps carry labels listing oxygenate content, ethanol or otherwise. Consequently, running on aviation fuel is the safest way to fly.

<sup>1</sup> To obtain a copy of the bulletin, "Use of Ground Fuels in Aviation Applications," write to Chevron Global Aviation, 1500 Louisiana Street, Houston, Texas 77002.

# Sources of More Information

## Emissions

CRC Report No. E-84, *Review of Prior Studies of Fuel Effects on Vehicle Emissions*, Coordinating Research Council, Alpharetta, Ga., August 2008.

## Gasoline

ASTM D4814, *Standard Specification for Automotive Spark-Ignition Engine Fuel*, ASTM International, West Conshohocken, Pa., 2009.

“Fuel Economy of Gasoline Vehicles,” Chevron Technical Bulletin FTB-7, 1999, [http://www.chevron.com/products/ourfuels/prodserv/fuels/technical\\_safety\\_bulletins/use\\_unleaded\\_gas.aspx](http://www.chevron.com/products/ourfuels/prodserv/fuels/technical_safety_bulletins/use_unleaded_gas.aspx).

“Gasoline for Your Car: Questions and Answers,” Publication 1580, American Petroleum Institute, Washington, D.C., 1996.

“Gasoline – Is It All the Same? What About Octane?” September 21, 2006, <http://www.api.org/aboutoilgas/gasoline/gasoline-octane.cfm>, accessed on August 25, 2008.

Gibbs, L.M., *Automotive Fuels – Gasoline, Encyclopedia of Energy, Technology and the Environment*, John Wiley & Sons, New York, 1994.

Gibbs, L.M., “Gasoline Additives – When and Why,” Paper No. 902104, Society of Automotive Engineers, Warrendale, Pa., 1990.

Gibbs, L.M., and B. R. Bonazza, “Chapter 8: Distillation and Vapor Pressure Data in Spark-Ignition Fuels,” *Manual 51 on Distillation and Vapor Pressure Measurement in Petroleum Products*, Rey G. Montemayor (ed.), ASTM International, West Conshohocken, Pa., 2008.

Gibbs, L.M., B. R. Bonazza, and R.L. Furey, “Chapter 3: Automotive Gasoline,” *Manual 1 on Significance of Testing for Petroleum Products*, 8th ed., Salvator J. Rand (ed.), ASTM International, West Conshohocken, Pa., 2009.

Hamilton, B., [B.Hamilton@irl.cri.nz](mailto:B.Hamilton@irl.cri.nz), “FAQ: Automotive Gasoline,” Nov. 17, 1996, <http://www.faqs.org/faqs/autos/gasoline-faq/part1/>, accessed on August 20, 2008.

Hochhauser, Albert M., et al., *Fuel Composition Effects on Automotive Fuel Economy – Auto/Oil Air Quality Improvement Research Program*, Paper No. 930138, Society of Automotive Engineers, Warrendale, Pa., March 1993.

“Longer-Term Storage of Gasoline,” Chevron Technical Bulletin FTB-6, 1996, [http://www.chevron.com/products/ourfuels/prodserv/fuels/technical\\_safety\\_bulletins/longterm\\_gasoline.aspx](http://www.chevron.com/products/ourfuels/prodserv/fuels/technical_safety_bulletins/longterm_gasoline.aspx).

Reynolds, Robert E., et al., *Changes in Gasoline III, Downstream Alternatives*, Inc., Bremen, Ind., 1996.

SAE J312, *Automotive Gasolines*, SAE International, Warrendale, Pa., 2001.

**U.S. Department of Energy**  
Energy Information Administration  
1000 Independence Ave., SW  
Washington, D.C. 20585  
+1-202-586-8800  
<http://www.eia.doe.gov/>

---

## Oxygenated Gasoline

“Alcohols and Ethers, A Technical Assessment of Their Application as Fuels and Fuel Components,” Publication 4261, American Petroleum Institute, Washington D.C., 2001.

American Petroleum Institute, “Ethanol Fact Sheet,” July 24, 2007, [http://www.api.org/aboutoilgas/otherfuels/upload/Ethanol\\_Fact\\_Sheet\\_07\\_24\\_07.pdf](http://www.api.org/aboutoilgas/otherfuels/upload/Ethanol_Fact_Sheet_07_24_07.pdf), accessed August 20, 2008.

Herman, M.J., and L.M. Gibbs, “Chapter 4: Fuel Oxygenates,” *Manual 1 on Significance of Testing for Petroleum Products*, 8th ed., Salvator J. Rand (ed.), ASTM International, West Conshohocken, Pa., 2009.

“Oxygenated Gasolines and Fuel Economy,” Chevron Technical Bulletin FTB-1, 1993.

“Use of Oxygenated Gasolines in Non-Automotive Engines,” Chevron Technical Bulletin CTB-22, 1992.

## Petroleum, General

“Petroleum Panorama,” *Oil and Gas Journal*, 57 (5), January 28, 1959.

## Petroleum Refining

Berger, Bill D. and Kenneth E. Anderson, *Refinery Operations*, PennWell, Tulsa, Okla., 1979.

Leffler, William L., *Petroleum Refining in Nontechnical Language*, 3d ed., PennWell, Tulsa, Okla., March 2000.

## Reformulated Gasoline

Committee D02 on Petroleum Products and Lubricants, “Research Report on Reformulated Spark-Ignition Engine Fuel,” D02:1347, ASTM International, West Conshohocken, Pa., 2009.

“Federal Reformulated Gasoline,” Chevron Technical Bulletin FTB-4, 1994.

### California Air Resources Board

1001 “I” Street  
P.O. Box 2815  
Sacramento, CA 95812  
+1-800-242-4450  
<http://www.arb.ca.gov/homepage.htm>

U.S. Environmental Protection Agency  
Office of Transportation and Air Quality  
Mail Code 6401A  
1200 Pennsylvania Avenue, NW  
Washington, D.C. 20460  
+1-202-564-1682  
<http://www.epa.gov/otaq>

## Regulations, California

### California Air Resources Board

1001 “I” Street  
P.O. Box 2815  
Sacramento, CA 95812  
+1-800-242-4450  
<http://www.arb.ca.gov/homepage.htm>

## Regulations, Federal

### Code of Federal Regulations, Title 40 – Protection of Environment

- Part 51 – Requirements for Preparation, Adoption,  
and Submittal of Implementation Plans  
Subpart S – Inspection/Maintenance  
Program Requirements
- Part 79 – Registration of Fuels and Fuel Additives
- Part 80 – Regulation of Fuels and Fuel Additives
- Part 85 – Control of Air Pollution  
From Mobile Sources
- Part 86 – Control of Emissions From  
New and In-Use Highway  
Vehicles and Engines

### U.S. Environmental Protection Agency

National Vehicle and Fuel Emissions Laboratory  
2000 Traverwood Drive  
Ann Arbor, MI 48105  
+1-734-214-4207

### U.S. Environmental Protection Agency

Office of Transportation and Air Quality  
Mail Code: 6401A  
1200 Pennsylvania Avenue, NW  
Washington, D.C. 20460  
+1-202-564-1682  
<http://www.epa.gov/otaq>

## Vehicles

*Bosch Automotive Handbook*, 7th ed., Robert Bosch GmbH, Stuttgart, 2007.

*Bosch Handbook for Automotive Electrics and Automotive Electronics*, 5th ed., Robert Bosch GmbH, Stuttgart, 2008.

Degobert, Paul, *Automobiles and Pollution*, Society of Automotive Engineers, Inc., Warrendale, Pa., 1995.

Garrett, T.K., *Automotive Fuels and Fuel Systems, Vol. 1: Gasoline*, Society of Automotive Engineers, Warrendale, Pa., 1991.

Heywood, John B., *Internal Combustion Engine Fundamentals*, McGraw-Hill, New York, 1988.

Jurgen, Ronald K. (ed.), *Automotive Electronics Handbook*, McGraw-Hill, New York, 1995.

Obert, E.F., *Internal Combustion Engines and Air Pollution*, Harper and Row, New York, 1973.





# Abbreviations

---

°API	degrees API, the unit of gravity in the American Petroleum Institute system	CFR	Code of Federal Regulations (USA)
°C	degrees Celsius, the unit of temperature in the metric (SI) system	CGSB	Canadian General Standards Board
°F	degrees Fahrenheit, the unit of temperature in the United States customary system	CO	carbon monoxide
ABS	automatic braking system	CO <sub>2</sub>	carbon dioxide
AFNOR	L'Association Française de Normalisation	CPE	chlorinated polyethylene
A/F	air-fuel ratio	CPFI	central port fuel injection
AKI	antiknock index average of an engine fuel's research octane number (RON) and motor octane number (MON) [(RON + MON)/2, simplified to (R + M)/2]	CRC	Coordinating Research Council (USA)
API	American Petroleum Institute	DC	deposit control
ASTM	ASTM International (formerly American Society for Testing and Materials)	DI	driveability index
BDC	bottom dead center; the position of the piston at the bottom of its stroke	DIN	Deutsches Institut für Normung
Btu	British thermal unit	DISI	direct injection spark ignition
C <sub>n</sub>	carbon number, <i>n</i> being a variable representing the number of carbon atoms in a hydrocarbon molecule	DOHC	dual overhead cam
CAI	controlled autoignition	DVPE	dry vapor pressure equivalent, the value of vapor pressure obtained by a specific method
CARB	California Air Resources Board	ECM	engine control module
CARBOB	California reformulated blendstock for oxygenate blending	EGR	exhaust gas recirculation
CCD	combustion chamber deposits	EPA	Environmental Protection Agency
CCDF	combustion chamber deposit flaking	Et	distillation profile volume percent evaporated at <i>t</i> temperature
CCDI	combustion chamber deposit interference	ETBE	ethyl tertiary butyl ether
CEN	Comité Européen de Normalisation (European Committee for Standardization)	EtOH	ethanol
		EU	European Union
		FCC	fluid catalytic cracking
		FTP 75	federal test procedure of the U.S. EPA for emissions certification of light-duty vehicles and involving a dynamometer emissions test cycle
		HC	hydrocarbon

---

HCCI	homogeneous charge compression ignition	NO <sub>2</sub>	nitrogen dioxide
I/M	inspection and maintenance program, a plan for checking the condition and performance of a vehicle's emission systems	NO <sub>x</sub>	nitrogen oxides (or oxides of nitrogen); NO + NO <sub>2</sub>
ISO	International Organization of Standardization	O <sub>3</sub>	ozone
IVD	intake valve deposits	OBD	on-board diagnostics, computer-based testing system in a vehicle engine that includes an engine control module for analyzing and diagnosing emission system malfunctions
JIS	Japanese Industrial Standard	OHC	overhead cam
JSA	Japanese Standards Association	ONR	octane number requirement (of an engine)
kPa	kilopascal, a unit of pressure in the metric (SI) system	ORI	octane requirement increase (of an engine)
LAC	lowest additive concentration (that can pass U.S. federal deposit control additive certification tests)	PAH	polycyclic aromatic hydrocarbon; hydrocarbons with two or more fused aromatic rings
LCFS	Low Carbon Fuel Standard	PCV	positive crankcase ventilation
LRP	lead replacement petrol	PFI	port fuel injector
MIL	malfunction indicator light	PM <sub>10</sub>	particulate matter with a particle size less than 10 microns
mm Hg	millimeter of mercury; a unit of pressure equal to 0.001316 atmosphere	PM <sub>2.5</sub>	particulate matter with a particle size less than 2.5 microns
MMT	methylcyclopentadienyl manganese tricarbonyl, an antiknock compound	PNA	polynuclear aromatic hydrocarbon
MON	Motor octane number	POM	polycyclic organic matter
MSDS	Material Safety Data Sheet	ppm	parts per million
MTBE	methyl tertiary butyl ether	psi	pounds per square inch, a unit of pressure in the U.S. customary system
NAAQS	National Ambient Air Quality Standards (USA)	RBOB	reformulated blendstock for oxygenate blending
NCWM	National Conference on Weights and Measures (USA)	RdON	road octane number
NMHC	non-methane hydrocarbons	RD	relative density
NMOG	non-methane organic gases	RFG	reformulated gasoline
NO	nitric oxide	RFS	Renewable Fuel Standard

## Abbreviations

---

ROG	reactive organic gases	TAME	tertiary amyl methyl ether
RON	Research octane number	TBA	tertiary butyl alcohol
rpm	revolutions per minute	TBI	throttle body injector
RVP	Reid vapor pressure, determined only by ASTM D323	TDC	top dead center; the position of the piston at the top of its stroke
SAE	SAE International (formerly Society of Automotive Engineers)	TEL	tetraethyl lead, an antiknock compound
SFTP	Supplemental Federal Test Procedure	TML	tetramethyl lead, an antiknock compound
SI	Système International d'Unités (International System of Units), metric system of measurement also, spark ignition	Tv	distillation profile temperature at <i>v</i> volume percent evaporated
SIP	State Implementation Plan, a plan to improve air quality (USA)	UL	Underwriters Laboratories Inc.
SO <sub>2</sub>	sulfur dioxide	U.S.	United States of America
SO <sub>x</sub>	sulfur oxides; SO + SO <sub>2</sub>	V/L	vapor-liquid ratio
STC	Supplemental Type Certificate, a certificate of approval from the U.S. Federal Aviation Administration that allows modification of an aircraft from its original design; can be obtained for the use of motor gasoline in place of aviation gasoline in some older planes	VLI	vapor lock index
		VOCs	volatile organic compounds
		VP	vapor pressure
		WOT	wide open throttle



# Index

- abnormal combustion . . . . . 5, 6, 90
- acceleration . . . . . 1, 2, 6, 7, 8, 11, 24, 48, 57, 64, 65, 71, 73, 74, 91, 93
- acid rain . . . . . 19
- adaptive learning . . . . . 26, 57, 71
- additives
- deposit control . . . . . 79-82
    - lowest additive concentration (LAC) . . . . 79, 81, 92, 100
  - gasoline . . . . . 41-44
    - ferrocene (iron) . . . . . 42, 43
    - methylcyclopentadienyl manganese tricarbonyl (MMT) . . . . . 42, 43, 82, 92, 100
    - tetraethyl lead (TEL) . . . . . 19, 42, 101
    - tetramethyl lead (TML) . . . . . 42, 101
- adsorption . . . . . 24, 37
- adulteration, gasoline . . . . . 40, 45
- after-running . . . . . 7
- air conditioner . . . . . 10, 11, 70, 93
- air filter . . . . . 64, 93
- air-fuel mixture . . . . . 5-8, 10, 12, 57, 61-63, 65, 70, 71, 74, 78, 89, 90
- air-fuel ratio (A/F) . . . . . 3, 18, 20, 22, 25, 26, 57, 62, 69, 71, 78, 89, 92, 99
- air intake manifold . . . . . 64, 66
- air intake system . . . . . 61, 64, 68
- air pollutants
- 1,3-butadiene . . . . . 20
  - acetaldehyde . . . . . 20
  - arsenic . . . . . 16
  - benzene . . . . . i, 16, 19, 20, 26-33, 35, 38, 57
  - cadmium . . . . . 16
  - carbon monoxide (CO) . . . . . 9, 10, 13, 15, 16, 18, 20-29, 53, 55, 56, 62, 68, 69, 78, 80, 89, 99
  - criteria pollutants . . . . . 15, 17, 25
  - formaldehyde . . . . . 20
  - hydrogen sulfide (H<sub>2</sub>S) . . . . . 15, 41
  - lead (Pb) . . . . . 15, 16, 19, 27, 36, 39, 42, 43, 45, 51, 68, 80, 93
  - nickel (Ni) . . . . . 16
  - nitrogen dioxide (NO<sub>2</sub>) . . . . . 13, 15, 16, 18, 100
  - nitrogen oxides (NO<sub>x</sub>) . . . . . 13, 16, 18-20, 22-30, 62, 69, 73, 78, 80, 100
  - ozone (O<sub>3</sub>) . . . . . 13-18, 26-28, 89, 100
  - particulates (PM<sub>2.5</sub>, PM<sub>10</sub>) . . . . . 15, 16, 19, 20, 22, 23, 100
  - polycyclic organic matter (POM) . . . . . 19, 20, 100
  - polycyclic aromatic hydrocarbon (PAH) . . . . . 16, 19, 100
  - primary pollutants . . . . . 15
  - secondary pollutants . . . . . 15
  - sulfates . . . . . 15
  - sulfur dioxide (SO<sub>2</sub>) . . . . . 15, 16, 18, 19, 25, 37, 101
  - vinyl chloride . . . . . 15
  - volatile organic compounds (VOCs) . . . . . 2, 5, 13, 17, 18, 20-22, 25-29, 62, 64, 65, 68, 69, 101
- air system . . . . . 61, 64-65
- alcohol . . . . . 38, 43, 52, 53, 54, 56-58
- aldehyde . . . . . 19, 20, 26
- alkylation . . . . . 35-37, 39
- Alliance of Automobile Manufacturers . . . . . 45
- altitude . . . . . 1, 5, 7, 8, 70, 91
- American Petroleum Institute (API) . . . . . 34, 44, 85, 95, 96
- API gravity . . . . . 41, 49
- aromatics . . . . . 9, 10, 17, 26, 28, 30-33, 36-39, 57-59, 92
- ASTM International . . . . . 4, 5, 44, 45, 47, 99
- standards – D86, D130, D323, D381, D525, D873, D1266, D1298, D2622, D2699, D2700, D3120, D3237, D4045, D4052, D4176, D4294, D4814 Annex A1, D4815, D4953, D5059, D5188, D5190, D5191, D5453, D5482, D5599, D5845, D6334, D6378, D6445, D7039 . . . . . 47
  - D4814 . . . . . 4, 40, 44-47, 49, 51, 57, 94
- atmospheric bottoms . . . . . 34-36, 38
- atmospheric distillation . . . . . 34, 35
- autoignition . . . . . 72, 74
- auto and equipment manufacturers . . . . . 8, 14, 21, 22, 42-46, 55, 59, 71, 78, 81, 93
- aviation fuel . . . . . 43, 50, 94
- backfiring . . . . . 1, 3
- biofuel . . . . . 30, 56
- block . . . . . 62, 63, 74

blow-by gases	64, 65	combustion cycle	i, 7, 61-62, 73, 87, 94
Bromine Number specification	27, 32	combustion gases	20, 61-64, 68, 78
BSI British Standards	44	combustion theory	9
butane	31, 33, 34, 39, 57	Comité Européen de Normalisation (CEN), <i>see European Committee for Standardization</i>	
California	9, 10, 13-17, 19, 22, 26-30, 32, 34, 38, 39, 42, 46, 53-55, 57, 60, 64, 68, 81, 89, 90, 92, 95, 97, 99	commingling	58
California Air Resources Board (CARB)	9, 14, 27-30, 38, 45, 53, 57, 95, 97, 99	Complex Model	28, 29, 55, 89
California reformulated blendstock for oxygenate blending (CARBOB)	55, 99	compression ratio	8, 22, 47, 61, 74, 78, 92
California State Automobile Association	90	connecting rod	61, 63
camshaft	43, 62, 63, 65, 70	contamination, gasoline	40, 41, 45, 51, 52, 59
Canada	6, 7, 42, 44, 56, 86	controlled autoignition combustion	74
Canadian General Standards Board (CGSB)	44, 99	Control of Hazardous Air Pollutants from Mobile Sources	30
carbon	8-10, 17-21, 30, 32, 33, 37, 53, 68, 80, 100	conventional engine technology	56, 61-72, 75
carbon dioxide (CO <sub>2</sub> )	20, 21, 68, 73, 99	conventional gasoline, <i>see gasoline, conventional</i>	
carbon number	31, 32, 37, 99	cooling system	22, 72
carburetor	2, 3, 4, 7, 12, 21, 43, 57, 65-67, 77, 79, 80, 89, 92	Coordinating Research Council (CRC)	45, 48, 60, 78, 81, 82, 95, 99
downdraft, four-barrel, sidedraft, two-barrel, updraft	65	copper	41, 45, 51
carburetor icing	2, 3, 4, 43	corrosion	1, 41, 45, 51, 55, 57, 59, 67
carcinogen	19, 20, 83	cracking	36, 39
catalytic converter	20, 25-27, 42, 45, 68-71, 73, 78	fluid catalytic cracking (FCC)	35-40, 99
close-coupled	68	hydrocracking	35, 36, 38
three-way	25, 68-70	thermal cracking	36
underfloor	68-70	crankcase	2, 63, 64, 79, 80
catalytic cracking	36	crankshaft	61, 63, 64, 67, 70, 74
catalytic exhaust emission controls	25, 42, 43, 68, 69	crude oil	i, 31-35, 38, 39, 41, 49, 89
central port fuel injection (CPFI)	66, 99	cylinder	5, 6, 8, 43, 47, 61-69, 72-74, 77, 79, 81, 90, 92
check engine light	72	cylinder deactivation	73-74
choke	4, 65	cylinder head	61-63, 73, 79
choke plate	65	delayed coking	36
coal	i, 18, 31	denaturing	56, 57
coker	35, 39	density	9, 10, 34, 41, 49, 54, 58, 100
cold start	2, 3, 21, 24, 66, 70, 71, 74, 78, 82, 89	desulfurization	37-39
combustion chamber	1, 5-8, 20-22, 26, 42, 61-65, 71, 73, 77-81, 90-92, 99	Deutsches Institut für Normung (DIN)	44, 99
combustion chamber deposits (CCD)	6, 8, 22, 42, 77-81, 91, 92, 99	diesel	18, 19, 20, 23, 30, 34-39, 50, 51, 61, 74
		dieseling	7

- diethyl ether . . . . . 53
- dimerization . . . . . 35, 38
- direct injection . . . . . 23, 24, 73
- direct injection spark ignition (DISI) . . . . . 73, 99
- director plate . . . . . 67, 77
- distillation . . . . . 34-37, 40, 48, 49, 56, 96
- distillation column . . . . . 34, 38
- distillation curve . . . . . 2
- distillation profile . . . . . 1-4, 27, 28, 31, 48, 99
- distillation residue . . . . . 5
- distillation unit . . . . . 39
- driveability . . . . . 1-6, 12, 40, 45, 57, 71, 77, 78, 89, 92, 99
- driveability index (DI) . . . . . 1, 3, 4, 99
- drivetrain . . . . . 61
- dry vapor pressure equivalent (DVPE) . . . . . 47
- dual overhead cam (DOHC) . . . . . 63, 99
- electronic control module (ECM) . . . . . 8, 48, 57, 66, 67, 69-73, 91, 100, 102
- emergency information . . . . . 83, 86
- emissions, see also *air pollutants* . . . . . 13-30, 80
- controls and control systems . . . . . 13, 14, 20, 23, 24, 25, 27, 42, 43, 57, 61, 68, 70, 72, 79
- evaporative . . . . . 1, 5, 21, 25-27, 60, 67, 68, 70, 72, 89
- exhaust . . . . . 2, 5, 14, 18-27, 30, 42, 43, 61, 64, 65, 68-70, 73, 74, 77-79, 89
- sources . . . . . 13-15, 17-19, 20-22, 25, 64, 65, 68, 75
- standards . . . . . 20, 21, 73, 89
- Brazil . . . . . 56
- California . . . . . 10, 13-17, 19, 22, 26-30, 32, 34, 38, 39, 42, 46, 53-55, 57, 60, 64, 89
- Canada . . . . . 42, 44, 56
- Europe . . . . . 5, 16, 19, 20, 23, 30, 39, 44, 56
- Japan . . . . . 23, 24, 30, 56
- United States . . . . . 5, 9, 10, 13-19, 22-24, 26-30, 34, 37-39, 42-46, 53-58, 89
- Renewable Fuel Standard (RFS) . . . . . 30, 54, 56
- National Ambient Air Quality Standards (NAAQS) . . . . . 10, 15, 28, 100
- engine
- design . . . . . i, 8, 10, 20, 22, 61-75, 78, 79, 82, 92, 93
- technology
- advanced . . . . . 73-75
- conventional (gasoline internal combustion) . . . . . i, 20, 23, 24, 61-72
- diesel . . . . . 20, 61, 74
- emissions
- catalytic converter . . . . . 18, 20, 25-27, 42, 45, 68-71, 73, 78
- controlled autoignition combustion . . . . . 74
- cylinder deactivation . . . . . 73-74
- electronic control module (ECM) . . . . . 8, 48, 57, 66, 67, 69-73, 91, 100, 102
- evaporative emissions control systems . . . . . 68, 70, 72
- exhaust gas recirculation (EGR) . . . . . 8, 69, 70, 72, 73, 79, 99
- fuel injection . . . . . 2, 3, 4, 7, 41, 43, 66, 67, 73, 77, 89, 99
- direct injection (DI) . . . . . 73
- on-board diagnostics
- (OBD) . . . . . 25, 42, 70, 72, 93, 100
- positive crankcase ventilation
- (PCV) . . . . . 64-65, 79, 100
- variable compression ratio . . . . . 74
- variable valve timing . . . . . 73
- engine control system . . . . . 69, 89, 91
- engine management computers . . . . . 7
- engine power . . . . . 3, 6-8, 61, 64, 72, 77, 78, 90, 91
- engine roughness . . . . . 1, 6, 7, 79
- ethanol . . . . . 2, 3, 4, 12, 21, 26, 27, 29, 30, 38, 47, 49, 52-60, 89, 94, 96, 99
- ether . . . . . 38, 39, 53-59, 89, 96
- ethyl alcohol, see *oxygenates, alcohols*
- ethylene . . . . . 56
- ethyl tertiary butyl ether (ETBE) . . . . . 12, 52-54, 57, 58, 89, 99
- Europe . . . . . 19, 20, 39, 44
- European Committee for Standardization . . . . . 5, 19, 20, 30, 36, 39, 43, 44, 99



exhaust gas recirculation (EGR) . . . . . 8, 69, 70, 72, 73, 79, 99  
 exhaust manifold . . . . . 62, 68, 69  
 exhaust oxygen sensor . . . . . 25, 57  
 exhaust pipe . . . . . 62, 68, 69, 70  
 exhaust system . . . . . 45, 61, 68-69  
 exhaust valve . . . . . 62, 63, 73, 80, 93  
 exhaust-valve seat recession . . . . . 43, 93  
 Federal Test Procedure 75 (FTP 75) . . . . . 22, 24, 78, 99  
 ferrocene . . . . . 42, 43  
 first aid . . . . . 86  
 fluid catalytic cracking (FCC) . . . . . 35-40, 99  
 four-stroke cycle . . . . . i, 61, 62  
 fuel cell . . . . . 61, 75  
 fuel economy . . . . . 1, 2, 8, 9-12, 20, 60, 61, 69, 73-75,  
 77, 89, 90, 92-96  
 fuel enrichment . . . . . 21  
     mixture enrichment . . . . . 65, 66, 70, 71  
 fuel filter . . . . . 41, 65, 66  
 fueling . . . . . 21, 30, 43, 83-84, 86  
 fuel injection system . . . . . 3, 4, 7, 41, 43, 66, 67, 73, 77, 89, 99  
 fuel injector . . . . . 3, 12, 57, 62, 68, 71, 73, 89  
 fuel lean . . . . . 3, 8, 12, 57, 62, 68, 71, 73, 89  
 fuel line . . . . . 66  
 fuel pump . . . . . 3, 41, 66  
 fuel rich . . . . . 21, 24, 57, 62  
 fuel system . . . . . 1, 3, 20, 21, 27, 30, 41, 43, 45, 55,  
 57, 59-61, 64-68, 80, 97  
 fuel tank . . . . . 21, 41, 43, 58, 65-68, 72, 83, 84, 87, 93  
     aluminum . . . . . 67  
     fiberglass . . . . . 59  
     plastic . . . . . 60, 67  
     steel . . . . . 67  
 gas cap . . . . . 68, 83  
 gasohol . . . . . 53  
 gasoil . . . . . 35, 38, 39  
 gasoline  
     altitude . . . . . 1, 5, 7, 91  
     appearance . . . . . 43, 45, 52  
     brand . . . . . 6, 81, 94  
     composition . . . . . 31-33  
     conventional . . . . . 2, 4, 9, 10, 12, 43, 51, 53, 55,  
         57, 58, 89, 90  
     disposal . . . . . 85-87  
     distribution . . . . . 5, 27, 40, 41, 44, 59  
     grades . . . . . 3, 7, 8, 9, 43, 91, 94  
         midgrade . . . . . 7  
         premium . . . . . 7, 9, 31, 40, 91, 92, 94  
         regular . . . . . 2, 7, 9, 31, 40, 94  
     handling . . . . . 83-87  
     oxygenated . . . . . 53-60, 89  
     properties . . . . . 1-12, 25-30, 31-34  
     specifications . . . . . 44-52  
     reformulated (RFG) . . . . . 2, 10, 11, 13, 14, 26, 27-30,  
         32, 38, 46, 51, 53-60, 89, 97  
         Brazil . . . . . 56  
         California . . . . . 14, 26, 27-30, 32, 38, 46, 53-60, 97  
         Canada . . . . . 42, 44, 56  
         European Union . . . . . 5, 30, 44, 56  
         Japan . . . . . 30, 44, 56  
         United States . . . . . 26, 27-30, 38, 44, 46, 53-60, 89, 97  
     seasonal . . . . . 1, 40, 45, 57  
         summer . . . . . 1, 2, 5, 9, 27, 28, 30, 39, 55, 58, 89  
         winter . . . . . 1, 2, 5, 9-10, 16, 27, 28, 53, 55-56, 89  
     storage . . . . . 21, 40, 45, 59, 60, 61, 67-68, 85, 94  
     straight-run . . . . . 34, 35, 38  
     TOP TIER Detergent . . . . . 81, 82  
     unleaded . . . . . 2, 5, 7, 19, 31, 39, 42, 43, 45, 51,  
         57, 68, 80, 81, 82, 92, 93, 95  
         lead replacement petrol (LRP) . . . . . 43, 93, 100  
     gasoline-electric hybrid . . . . . 61, 74, 75  
     gasoline pump . . . . . 6, 83, 84, 90, 94  
     grain alcohol . . . . . 53  
     greenhouse gas . . . . . 17, 20, 61  
     heating value . . . . . 8-12, 90, 94  
     heptane . . . . . 36, 47, 49  
     homogeneous charge compression ignition (HCCI) . . . . . 74

- hot fuel handling . . . . . 1-3, 67
- hot soak . . . . . 3, 67, 77
- hot start . . . . . 2
- hybrid, gasoline-electric . . . . . 61, 74, 75
- hydrocarbon (HC) . . . . . 2, 3, 5, 9, 10, 17, 19, 20, 22-24, 26, 27, 30-37, 42, 45, 50, 53, 54, 57-60, 75, 78, 80, 89, 99, 100
- hydrocracking . . . . . 35, 36, 38
- hydrogen . . . . . 32, 33, 36-39, 53, 75
- hydrotreating . . . . . 35, 37-39
- idle . . . . . 1, 7, 11, 65, 70
- Inspection and Maintenance (I/M) . . . . . 24-25, 95, 100
- intake air heater . . . . . 4
- internal combustion engine . . . . . i, 5, 20, 61-72, 74, 75, 89, 97
- International Organization for Standardization (ISO) . . . . . 44, 100
- iron . . . . . 42, 43
- isomerization . . . . . 35, 37
- isomers . . . . . 32, 33, 37
- Japan . . . . . 23, 44, 56
- Japan Standards Association (JSA) . . . . . 23, 44, 56, 100
- jet . . . . . 65
- keep-clean performance . . . . . 80-82
- kerosene . . . . . i, 34, 35, 40
- knock . . . . . 1, 5-8, 47, 48, 58, 70-72, 74, 78, 90-93
- antiknock additives . . . . . 19, 36, 42-43, 92, 93
- antiknock index (AKI) . . . . . 6, 7, 8, 45, 47, 72, 78, 90, 91, 92, 99
- antiknock performance . . . . . 6-8, 90
- antiknock quality . . . . . 7, 41, 42, 47, 78, 90
- antiknock rating, see also *octane number* . . . . . 6, 7, 91
- knock sensor . . . . . 7, 8, 72, 78, 91
- Modified Uniontown Technique . . . . . 6, 48
- Motor octane number (MON) . . . . . 6, 47, 90, 99, 100
- octane number . . . . . 6, 7, 32, 36-40, 42, 45, 47, 48, 58, 90-92, 94
- octane number requirement  
    (ONR) . . . . . 6-8, 78, 79, 91, 92, 100
- Research octane number (RON) . . . . . 6-8, 32, 36, 37, 47, 48, 54, 72, 90-92, 99, 101
- Road octane number (RdON) . . . . . 6, 48, 100
- spark knock . . . . . 5, 6, 7, 70, 90
- trace knock . . . . . 7, 48
- L'Association Française de Normalisation (AFNOR) . . . . . 44, 99
- lead . . . . . 15, 16, 19, 27, 36, 39, 42, 43, 45, 51, 68, 80, 92, 93
- lead replacement petrol (LRP) . . . . . 43, 93, 100
- legislation, U.S.
- Air Pollution Control Act of 1955 . . . . . 14
- Air Quality Act of 1967 . . . . . 14
- Clean Air Act . . . . . 15, 22
- 1963 . . . . . 14
- 1970 . . . . . 14
- 1977 . . . . . 42, 57
- 1990 . . . . . 20, 25, 26, 81
- Energy Independence and Security Act of 2007 . . . . . 30
- Energy Policy Act of 2005 . . . . . 26, 30, 53
- National Environmental Policy Act . . . . . 14
- Low Carbon Fuels Standard (LCFS) . . . . . 30, 100
- lowest additive concentration (LAC) . . . . . 79, 81, 92, 100
- lubricants . . . . . 8, 11, 93
- malfunction indicator light (MIL) . . . . . 72, 100
- manganese . . . . . 42, 82, 92, 100
- marine fuel . . . . . 38, 59
- Material Safety Data Sheet (MSDS) . . . . . 83, 100
- mercaptan . . . . . 38, 41
- methane . . . . . 17, 22-24, 37, 57, 100
- methanol . . . . . 38, 52, 55-58
- methylcyclopentadienyl manganese tricarbonyl  
(MMT) . . . . . 42, 43, 82, 92, 100
- methyl tertiary butyl ether  
(MTBE) . . . . . 12, 27, 29, 30, 38, 39, 52-60, 89, 92, 100
- Modified Uniontown Technique . . . . . 6, 48
- motorcycles . . . . . 65
- Motor octane number (MON) . . . . . 6, 47, 90, 99, 100
- muffler . . . . . 68
- naphtha . . . . . 34
- naphthene . . . . . 31, 33, 36, 40
- National Ambient Air Quality Standards  
(NAAQS) . . . . . 10, 15, 28, 100

National Conference on Weights and Measures (NCWM) . . . . . 56, 100

natural gas, see also *methane* . . . . . 37, 57

nitrogen . . . . . 18-20, 22, 32, 34, 36, 38, 69

nonattainment area . . . . . 10

    carbon monoxide . . . . . 9, 27, 28, 53, 55, 56, 89

    ozone . . . . . 16, 27, 28, 89

    particulates . . . . . 19

non-methane organic gas (NMOG) . . . . . 17, 22, 100

normal octane . . . . . 32, 33

octane grade, see also *Research octane number* . . . . . 7, 91

octane number . . . . . 6, 7, 32, 36-40, 42, 45, 47, 48, 58, 90-92, 94

octane number requirement (ONR) . . . . . 6-8, 78, 79, 91, 92, 100

octane requirement increase (ORI) . . . . . 8, 77-79, 100

oil pan . . . . . 63

oil pump . . . . . 63

oil sands . . . . . 31

olefin . . . . . 9, 17, 26, 28, 31-33, 36-39, 41, 57

on-board diagnostics (OBD) . . . . . 25, 42, 70, 72, 93, 100

overhead cam (OHC) . . . . . 63, 100

owner's manual . . . . . 6, 7, 43, 59, 91

oxygen (O<sub>2</sub>) . . . . . 9, 10, 18-22, 25-29, 32, 38, 40-43, 49, 50, 52-58, 68-72, 75

oxygenated gasoline, see *gasoline, oxygenated*

oxygenates

    alcohols . . . . . 38, 53, 54, 57, 58

        ethanol . . . . . 2, 3, 4, 12, 21, 26, 27, 29, 30, 38, 47, 49, 52-60, 89, 94, 96, 99

        isobutyl alcohol . . . . . 56

        isopropyl alcohol . . . . . 56

        methanol . . . . . 38, 52, 55-58

        tertiary butyl alcohol (TBA) . . . . . 56, 58, 101

    ethers . . . . . 38, 39, 53, 54, 55, 56, 57, 58, 59

        ethyl tertiary butyl ether (ETBE) . . . . . 12, 52-54, 57, 58, 89, 99

        methyl tertiary butyl ether (MTBE) . . . . . 12, 27, 29, 30, 38, 39, 52-60, 89, 92, 100

        tertiary amyl methyl ether (TAME) . . . . . 52, 53, 54, 57, 58, 89, 101

oxygen sensor . . . . . 21, 40, 42, 43, 57, 70-72

ozone (O<sub>3</sub>) . . . . . 13-18, 26-28, 89, 100

paraffins . . . . . 17, 31, 33-37

particulates . . . . . 15, 16, 19, 20, 22, 23, 100

permeation . . . . . 21, 30, 60, 67, 68

petrol . . . . . i, 5, 89

phase separation . . . . . 45, 58, 59

pinging, see also *knock* . . . . . 5, 90

pintle . . . . . 67, 77

piston . . . . . 6, 61-65, 73, 78, 79, 99, 101

piston crown . . . . . 6

piston ring . . . . . 43, 63, 64

piston top . . . . . 79

port fuel injection . . . . . 2, 66, 73

port fuel injector (PFI) . . . . . 66, 67, 71, 77, 81

positive crankcase ventilation (PCV) . . . . . 64-65, 79, 100

post-ignition . . . . . 6, 7

powertrain . . . . . 61, 72, 74, 75

Predictive Model . . . . . 28, 30, 55, 89

preignition . . . . . 6, 7

purge control valve . . . . . 68

reactive organic gases (ROG) . . . . . 16, 17, 100

refining . . . . . 9, 28-45, 47, 49, 51, 53, 57, 91, 96

reformate . . . . . 39

reformer . . . . . 39

reforming . . . . . 36, 37

reformulated blendstock for oxygenate blending (RBOB) . . . . . 55, 58, 100

reformulated gasoline (RFG), see *gasoline, reformulated (RFG)*

Reid vapor pressure (RVP) . . . . . 47, 101

relative density (RD) . . . . . 41, 49, 54, 58, 100

Renewable Fuel Standard (RFS) . . . . . 27, 30, 54, 56, 100

Research octane number (RON) . . . . . 6-8, 32, 36, 37, 47, 48, 54, 72, 90-92, 99, 101

resid conversion unit . . . . . 39

returnless fuel system . . . . . 66

Road octane number (RdON) . . . . . 6, 48, 100

Rocky Mountain states . . . . . 7, 91

- rough idling . . . . . 1
- run-on . . . . . 7
- SAE International . . . . . 45, 96, 101
- seal . . . . . 30, 60
- sea level . . . . . 7, 91
- sensor. . . . . 7, 8, 21, 25, 40, 42, 43, 57, 66, 69, 70-72, 78, 91
- service station . . . . . 21, 30, 41, 43, 55, 59, 79, 84, 85, 90
- shale oil . . . . . 31
- silicon . . . . . 40
- Simple Model . . . . . 28, 29
- smog . . . . . 14, 16, 25
- Society of Automotive Engineers,  
see also *SAE International*. . . . . 8, 9, 45, 78, 79, 95-97 101
- solvent extraction unit. . . . . 39
- Southwest Research Institute. . . . . 81
- spark-ignition . . . . . 61, 73, 74, 81, 82, 89, 90, 95-97, 99, 101
- spark plug . . . . . 5, 6, 20, 42, 43, 62, 66, 72, 73, 80, 90
- spark timing. . . . . 6-8, 22, 48, 70-72, 91
- specific gravity . . . . . 41, 49, 54
- squish. . . . . 79
- stall . . . . . 1, 2, 4
- standards organizations
- Agência Nacional do Petróleo (ANP), Brazil. . . . . 56
  - ASTM International (formerly American Society for Testing and Materials) . . . . . 4, 5, 44, 45, 47-52, 95-97, 99
  - BSI British Standards, UK . . . . . 44
  - Canadian General Standards Board (CGSB), Canada . . . . . 44, 99
  - Deutsches Institut für Normung (DIN), Germany. . . . . 44, 99
  - European Committee for Standardization (CEN), Europe . . . . . 5, 19, 20, 30, 36, 39, 43, 44, 99
  - International Organization for Standardization (ISO). . . . . 44, 100
  - Japan Standards Association (JSA), Japan. . . . . 44, 100
  - L'Association Française de Normalisation (AFNOR), France. . . . . 44, 99
- state implementation plan (SIP). . . . . 5, 15, 19, 101
- stoichiometric air-fuel ratio . . . . . 57, 62, 69, 70, 73
- Substantially Similar Rule . . . . . 54, 55, 57
- sulfur . . . . . 18, 19, 25, 27-30, 32, 34, 36-39, 41, 45, 50, 51, 57, 73
- sulfur dioxide (SO<sub>2</sub>). . . . . 15, 16, 18, 19, 25, 37, 101
- sulfur oxides . . . . . 25, 27, 101
- supercharger . . . . . 8, 64
- supercharging . . . . . 74
- Supplemental Federal Test Procedure (SFTP) . . . . . 21, 24, 101
- Supplemental Type Certificate (STC) . . . . . 94, 101
- surface ignition . . . . . 6, 7
- surging. . . . . 3
- swept volume. . . . . 61
- terneplate. . . . . 67
- tertiary amyl methyl ether (TAME) . . . . . 52, 53, 54, 57, 58, 89, 101
- tertiary butyl alcohol (TBA) . . . . . 58, 101
- testing
- adulteration . . . . . 40
  - deposit control additives . . . . . 80, 81
    - TOP TIER Detergent Gasoline tests. . . . . 82
  - emissions
    - Federal Test Procedure 75 (FTP 75). . . . . 22, 24, 78
    - Supplemental Federal Test Procedure (SFTP). . . . . 21, 24
    - Japan . . . . . 24
    - methylcyclopentadienyl manganese tricarbonyl (MMT) . . . . . 42
  - fuel economy . . . . . 9, 11, 12, 90
  - gasoline specifications (U.S.) . . . . . 44, 45, 47-52
  - octane number . . . . . 6, 90
  - organizations . . . . . 44
- toxicity. . . . . 58
- thermal cracking . . . . . 36
- thermostat . . . . . 4
- throttle. . . . . 1, 3, 4, 6, 7, 48, 64, 65, 66, 70, 71, 79, 80, 101
- timing belt . . . . . 63
- timing chain. . . . . 63
- tire pressure . . . . . 10, 11, 93
- toluene. . . . . 36, 40
- TOP TIER Detergent Gasoline . . . . . 81, 82

---

transmission . . . . . 10, 70, 74  
 turbocharger . . . . . 8, 64  
 turbocharging . . . . . 64, 70, 72, 74, 81  
 two-stroke cycle . . . . . 87, 94  
 U.S. Code of Federal Regulations . . . . . 25  
 U.S. Environmental Protection Agency . . . . . 5, 10, 11, 14-22,  
 24-30, 34, 37, 38, 42, 43, 45, 53, 54, 56-58, 81, 82, 85, 92,  
 95, 97, 99  
 U.S. EPA National Vehicle and  
 Fuel Emission Laboratory . . . . . 25, 95  
 U.S. EPA Office of Transportation and  
 Air Quality . . . . . 20, 95, 97  
 U.S. Federal Trade Commission . . . . . 6  
 valve . . . . . 8, 12, 43, 59, 61-66, 68, 69, 73, 74,  
 77-82, 84, 87, 92, 93, 100  
 valve train . . . . . 63  
 vapor-liquid ratio (V/L) . . . . . 1, 3, 4, 49, 58, 101  
 vapor lock . . . . . 1, 2, 3, 4, 45, 58, 67  
 vapor lock index (VLI) . . . . . 1, 3, 101  
 vapor pressure . . . . . 1-5, 21, 25, 27-30, 39, 45, 47, 49,  
 55, 57, 58, 89, 96  
 vapor recovery system . . . . . 21  
 V engine . . . . . 63, 65  
 venturi . . . . . 4, 65  
 visbreaking . . . . . 36  
 volatile organic compound (VOC) . . . . . 2, 5, 13, 17, 18,  
 20-22, 25-29, 62, 64, 65, 68, 69, 101  
 volatility . . . . . 1-5, 28, 30-32, 40, 45, 55, 57-58  
 wastegate . . . . . 64  
 water tolerance . . . . . 45, 58  
 wheel alignment . . . . . 10, 11, 93  
 wide-open throttle (WOT) . . . . . 71, 101  
 zinc . . . . . 41, 67

# Notes

---





## Notes

---



Modern motor gasolines have evolved into a sophisticated mix of performance and environmental chemistry that maximizes engine operations and cleanliness. As both the gasoline and automotive industries have matured and environmental issues have gained importance, consumers have come to expect smooth, efficient, low-emission driving. And today's gasolines deliver on those expectations, keeping travel – and life – simplified.





**Chevron Products Company**  
6001 Bollinger Canyon Road  
San Ramon, CA 94583

[www.chevron.com/products/ourfuels/prodserv/fuels/technical\\_safety\\_bulletins/](http://www.chevron.com/products/ourfuels/prodserv/fuels/technical_safety_bulletins/)

Chevron Products Company is a division of a wholly owned subsidiary of Chevron Corporation.

© 2009 Chevron Corporation. All rights reserved.  
Chevron is a trademark of Chevron Corporation.

 Recycled/Recyclable paper

